



Cam Follower

THK General Catalog

Cam Follower

THK General Catalog

A Product Descriptions

Features and Types	A 19-4
Features of the Cam Follower	A 19-4
• Structure and Features	A 19-4
• Cam Follower with Grease Nipple	A 19-5
• Cam Follower Containing Thrust Balls	A 19-5
Types of the Cam Follower	A 19-6
• Types and Features	A 19-6
• Options	A 19-9
Classification Table	A 19-10
Point of Selection	A 19-12
Nominal Life	A 19-12
Track Load Capacity	A 19-13
Accuracy Standards	A 19-14
Radial Clearance	A 19-14
Dimensional Drawing, Dimensional Table	
Model CF-AB Cam Follower with Grease Nipple..	A 19-16
Model CF (Popular Type)	A 19-18
Cam Follower with Hexagon Socket Model CF-A ..	A 19-20
Eccentric Cam Follower with Grease Nipple Model CFH-AB ..	A 19-22
Eccentric Cam Follower with Hexagon Socket Model CFH-A ..	A 19-24
Cam Follower Containing Thrust Balls Model CFN-R-A..	A 19-26
Cam Follower with Tapped Greasing Hole Model CFT ..	A 19-28
Outer-ring Compact-type Cam Follower Model CFS-A ..	A 19-30
Easy-mount Cam Follower Model CF-SFU ..	A 19-32
Double-row Cylindrical-roller Cam Follower Model NUCF-AB ..	A 19-34
Point of Design	A 19-36
Fit	A 19-36
Installation	A 19-36
Accessories	A 19-38
Cam Follower Accessories	A 19-38
Grease nipple	A 19-39
Model No.	A 19-40
• Model Number Coding	A 19-40
Precautions on Use	A 19-42

B Support Book (Separate)

Features and Types	B 19-4
Features of the Cam Follower	B 19-4
• Structure and Features	B 19-4
• Cam Follower with Grease Nipple	B 19-5
• Cam Follower Containing Thrust Balls	B 19-5
Types of the Cam Follower	B 19-6
• Types and Features	B 19-6
• Options	B 19-9
Classification Table	B 19-10
Point of Selection	B 19-12
Nominal Life	B 19-12
Track Load Capacity	B 19-14
• Example of Calculating a Track Load Capacity ..	B 19-14
Mounting Procedure and Maintenance ..	B 19-15
Installation	B 19-15
Contamination Protection and Lubrication ..	B 19-17
Accessories	B 19-18
Cam Follower Accessories	B 19-18
Grease nipple	B 19-19
Model No.	B 19-20
• Model Number Coding	B 19-20
Precautions on Use	B 19-22

Features of the Cam Follower

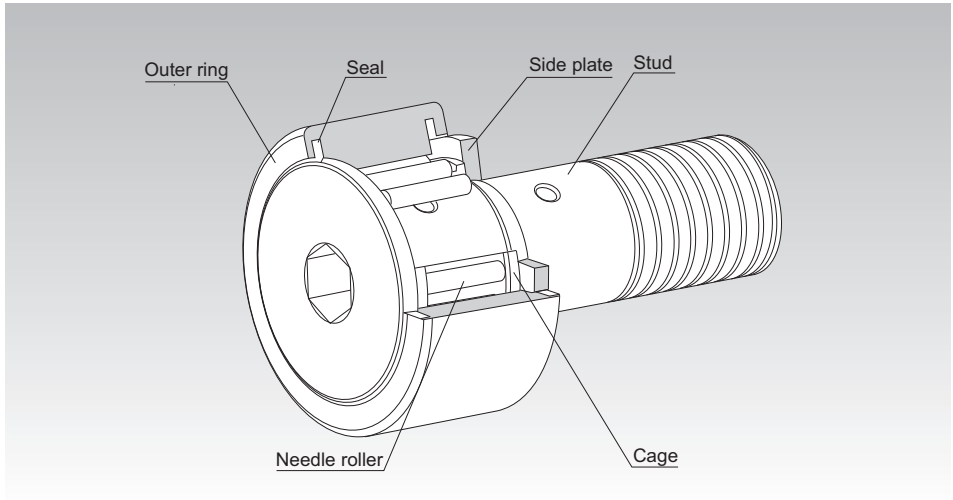

Fig.1 Structure of Cam Follower Model CF...UU-A

Structure and Features

The Cam Follower is a compact and highly rigid bearing with a shaft. It contains needle rollers and is used as a guide roller for cam mechanisms or straight motion.

Since its outer ring rotates while keeping direct contact with the mating surface, this product is thick-walled and designed to bear an impact load.

Inside the outer ring, needle rollers and a precision cage are incorporated. This prevents the product from skewing and achieves a superb rotation performance. And, as a result, the product is capable of easily withstanding high-speed rotation.

There are two types of the outer ring in shape: spherical and cylindrical. The spherical outer ring easily absorbs a distortion of the shaft center when the cam follower is installed and helps lighten a biased load.

The Cam Follower is used in a wide range of applications such as cam mechanisms of automatic machines, dedicated machines as well as carrier systems, conveyors, bookbinding machines, tool changers of machining centers, pallet changers, automatic coating machines, and sliding forks of automatic warehouses.

Cam Follower with Grease Nipple

With previous models it was necessary to fabricate a jig in order to install a plug or grease nipple. The Model CF-AB Cam Follower with grease nipples comes equipped with grease nipples on both sides, so it can be used immediately, without modification.

An Allen wrench can be used to anchor the stud from either the head or the threaded end, and it can be lubricated from either end as well. This ensures that there will be adequate space to install the unit and perform maintenance, improving work efficiency.

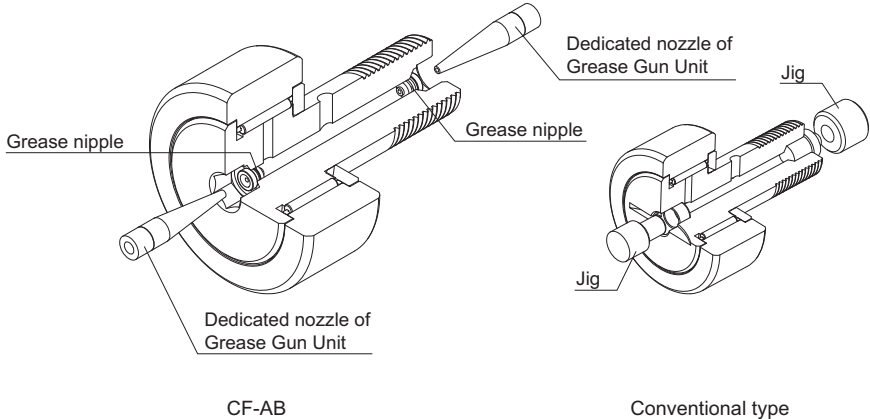

Cam Follower Containing Thrust Balls

Even a slight mounting error in a high speed cam mechanism operating in a harsh environment could cause abnormal wear to the thrust unit of the cam follower. In such a case, using Cam Follower Containing Thrust Balls model CFN will bring about a significant effect in increasing the durability.

Models CFN5 to 12 are standard-stock items. If desiring a size other than the standard items, contact THK.

Model CFN is capable of receiving a thrust load caused by a slight mounting error. However, it is necessary to minimize a component of thrust force, or prevent it from occurring, when designing the cam mechanism and installing the Cam Follower.

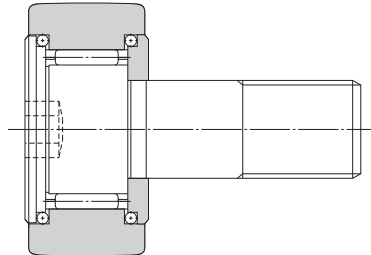

Fig.2

Types of the Cam Follower

Types and Features

Cam Follower with Grease Nipple Model CF-AB

Specification Table⇒ **A19-16**

A hexagonal socket is provided on both stud ends, and a grease nipple for greasing is fitted to the inside. Therefore, lubrication and mounting from both directions is possible.

Stud diameter: 12–30 mm

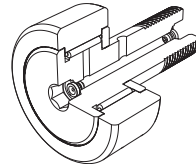

Model CF-AB

Popular Type Cam Follower Model CF

Specification Table⇒ **A19-18**

It is a popular type of Cam Follower provided with a driver groove on the head of the stud.

Stud diameter: 5–10 mm

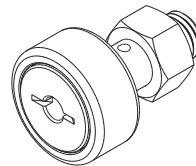

Model CF

Cam Follower with a Hexagon Socket Model CF-A

Specification Table⇒ **A19-20**

Since the stud head has a hexagon socket, this model can easily be installed using a hexagon wrench.

Stud diameter: 3–10 mm

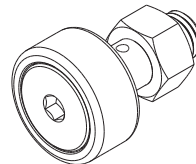

Model CF-A

Eccentric Cam Follower Models CFH-AB, CFH-A

Specification Table⇒ **A**19-22

Because there is an eccentricity of 0.25 to 1.0 mm between the mounting shaft of the stud and the stud head, slight positioning adjustments can easily be made simply by rotating the stud. This eliminates the need to align the cam follower with the cam groove or perform precision machining on the mounting hole, greatly reducing the time and labor required for machining and assembly.

Model CFH-AB: Equipped with grease nipple and hexagonal sockets; compatible with stud diameters of 12 to 30 mm.

Model CFH-A: Equipped with hexagonal sockets; compatible with stud diameters of 5 to 10 mm.

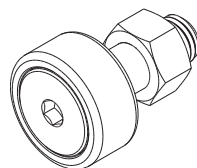

Model CFH-A

Cam Follower Containing Thrust Balls Model CFN-R-A

Specification Table⇒ **A**19-26

On the inside, this Cam Follower model is equipped with thrust-load ball bearings. This effectively prevents friction and wear on the slip surface when a thrust load occurs due to faulty installation or the like.

Stud diameter: 5–12 mm

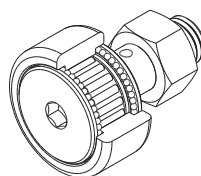

Model CFN-R-A

Cam Follower with a Tapped Hole for Greasing Model CFT

Specification Table⇒ **A**19-28

Basically the same as the popular type Cam Follower, this model is provided with tapped holes for piping on the stud head and the thread.

It is optimal for locations where an integrated piping for greasing is required.

Stud diameter: 6–30 mm

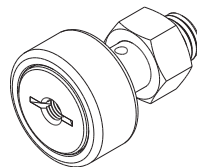

Model CFT

Outer-ring Compact-type Cam Follower Model CFS-A

Specification Table⇒ **A19-30**

This Cam Follower contains extremely fine needle rollers.

The outer ring external diameter is extremely small relative to the stud diameter, allowing a compact design.

Stud diameter: 2.5–6 mm

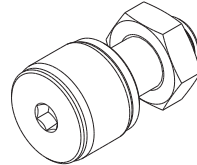

Model CFS-A

Easy-mount Cam Follower Model CF-SFU

Specification Table⇒ **A19-32**

For easy mounting, the stud is equipped with a slot enabling it to be secured with a screw. This greatly reduces the time and labor required for installation and is ideal for applications where there is no space to secure the stud with a nut.

Stud diameter: 6–20 mm

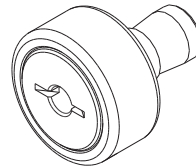

Model CF-SFU

Model NUCF-AB Double-row Cylindrical-roller Cam Follower

Specification Table⇒ **A19-34**

This model, which employs a double row of cylindrical rollers, can accommodate high radial loads.

A hexagonal socket is provided on both stud ends, and a grease nipple for greasing is fitted to the inside. Therefore, lubrication and mounting from both directions is possible.

Stud diameter: 16–30 mm

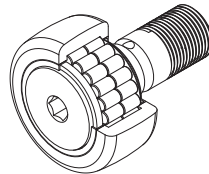

Model NUCF-AB

Options

Note: Different features and options are available, depending on the model. For details, please refer to the dimension table for the product in question.

● Roller guide

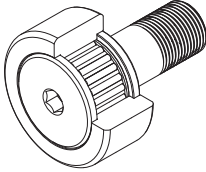

With cage (No Symbol)

The caged format, which offers optimal lubrication conditions, is best for high-speed rotation.

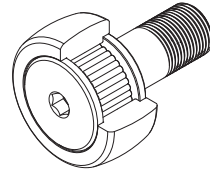

Full rollers (V)

The full-complement roller format is best for low-speed rotation and heavy loads.

Note: Please make sure to follow the lubrication schedule.

● Type of material

Carbon steel and stainless steel are available.

Stainless steel, which is more resistant to corrosion, is the best choice for use in clean rooms and other oil-free environments.

● With/without a seal

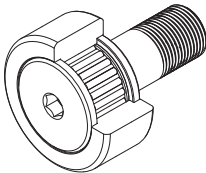

Without seal (No symbol)

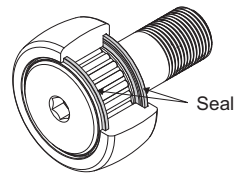

With seal (UU)

Equipped with a highly wear-resistant synthetic rubber seal to keep foreign matter out of the unit's interior.

● Outer ring outer surface configuration

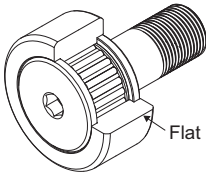

Cylindrical outer ring (No Symbol)

This model offers an expansive area of contact between rolling surfaces and is therefore ideal for heavy loads and low-rigidity rolling surfaces.

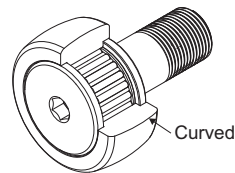

Spherical outer ring (R)

This helps alleviate the effects of an eccentric load in the event of adverse conditions around the outer ring and rolling surface.

Classification Table

	Model No.	Main dimensions				Options				
		Stud diameter	Outer diameter	Outer ring width	Overall length	Roller guide		Material		
		[mm]	[mm]	[mm]	[mm]	With cage	Full rollers	Carbon steel	Stainless steel	
Popular type	CF-AB	Φ12-30	Φ30-90	14-35	40-100	○	○	○	○	
	CF	Φ5-10	Φ13-26	9-12	23-36	○	○	○	○	
	CF-A	Φ3-10	Φ10-26	7-12	17-36	○	○	○	○	
Eccentric type	CFH-AB	Φ12-30	Φ30-90	14-35	40-100	○	○	○	○	
	CFH-A	Φ5-10	Φ13-26	9-12	23-36	○	○	○	○	
With thrust balls	CFN-R-A	Φ5-12	Φ13-30	9-14	23-40	○	—	○	—	
With tapped grease hole	CFT	Φ6-30	Φ16-90	11-35	28-100	○	○	○	○	
Compact outer ring type	CFS-A	Φ2.5-6	Φ5-12	3-7	9.5-21.5	○	○	○	○	
Easy-mount type	CF-SFU	Φ6-20	Φ16-47	11-24	32-50.5	○	—	○	—	
Double-row cylindrical-roller type	NUCF	Φ16-30	Φ35-90	18-35	52-100	—	○	○	—	

Note1) It is recommended to use nipples for greasing. Nipples can be attached at your request.

Note2) Nipples and fittings can be attached at your request.

					Features (installation and greasing)	Description page
Seal		Outer ring shape				
With	Without	Cylinder	Spherical surface			
○	○	○	○		Installation: Use the hex sockets located at both ends of the stud. Greasing: Use the internal nipples at either end or the grease hole drilled into the stud shaft.	A19-16
○	○	○	○		Installation: Use the driver groove in the stud head. Greasing: Use the grease hole* drilled into the stud head.	A19-18
○	○	○	○		Installation: Use the hex socket in the stud head. Greasing: Cannot re-grease.	A19-20
○	○	○	○		<ul style="list-style-type: none"> The position of the outer diameter of the outer ring can be fine-tuned with the eccentricity mechanism → Useful when installing and aligning multiple cam followers. Installation: Use the hex sockets located at both ends of the stud. Greasing: Use the internal nipples at either end.	A19-22
○	○	○	○		<ul style="list-style-type: none"> The height of the outer diameter of the outer ring can be fine-tuned with the eccentricity mechanism → Useful when installing and aligning multiple cam followers. Installation: Use the hex socket in the stud head. Greasing: Cannot re-grease.	A19-24
—	○	—	○		<ul style="list-style-type: none"> The thrust balls absorb axial loads to prevent friction and wear of the slip surface → Optimal for environments where installation errors, etc. may occur. Installation: Use the hex socket in the stud head. Greasing: Stud diameter 5 to 10 mm: Cannot re-grease. Stud diameter 12 mm: Use the grease hole* in the stud end or the grease hole drilled into the stud shaft.	A19-26
○	○	○	○		<ul style="list-style-type: none"> Tapped grease holes at both ends of the stud → Ideal for connecting to a central lubrication system, such as when using a large number of cam followers. Installation: Use the driver groove in the stud head. Greasing: Stud diameter 6 to 10 mm: Use a nipple or fitting on the stud head. Stud diameter 12 mm or larger: Use nipples or fittings on the stud ends or the grease hole drilled into the stud shaft.	A19-28
—	○	○	—		<ul style="list-style-type: none"> The outer diameter of the outer ring follows closely to that of the stud diameter → Allows for compact design Installation: Use the hex socket in the stud head. Greasing: Cannot re-grease.	A19-30
○	—	○	○		<ul style="list-style-type: none"> Designed to be fixed in place with set screws → Reduced assembly time makes it ideal when installing large numbers of cam followers. Installation: Lock into place with a set screw. Greasing: Use the grease hole* drilled into the stud head.	A19-32
—	○	○	○		<ul style="list-style-type: none"> Employs double rows of cylindrical rollers for high load capacity → Ideal for supporting heavy loads Installation: Use the hex sockets located at both ends of the stud. Greasing: Use the internal nipples at either end or the grease hole drilled into the stud shaft.	A19-34

Nominal Life

[Static Safety Factor]

The basic static load rating C_0 refers to the static load with constant direction and magnitude, under which the calculated contact stress in the center of the contact area between the roller and the raceway under the maximum load is 4000 MPa. (If the contact stress exceeds this level, it will affect the rotation.) This value is indicated as “ C_0 ” in the dimensional tables. When a load is statically or dynamically applied, it is necessary to consider the static safety factor as shown below.

$$\frac{C_0}{P_0} = f_s$$

f_s : Static safety factor in relation to C_0
(see Table1)

C_0 : Basic static load rating (kN)

P_0 : Radial load (kN)

The permissible load (F_0) indicates the permissible value of the applied load determined by the strength of the stud section of the Cam Follower. Therefore, it is necessary to consider the static safety factor f_M against F_0 as well as f_s .

$$\frac{F_0}{P_0} = f_M$$

f_M : Static safety factor in relation to F_0
(see Table1)

F_0 : Permissible load (kN)

P_0 : Radial load (kN)

* The minimum value for the static safety factor is based on the presumption of appropriate lubrication and optimal conditions for mounting and assembly. It is not possible to calculate the effect on internal loads that may be caused by improper mounting, deformation of mounting components, or the like. Please take all necessary action to ensure safety.

Table1 Static Safety Factor (f_s, f_M)

Load conditions	Lower limit of f_s and f_M
Normal load	1 to 2
Impact load	2 to 3

[Nominal Life]

The service life of the Cam Follower is obtained from the following equation.

$$L = \left(\frac{f_T \cdot C}{f_w \cdot P_c} \right)^{\frac{10}{3}} \times 10^6$$

L : Nominal life
(The total number of revolutions that 90% of a group of identical Cam Follower units independently operating under the same conditions can achieve without showing flaking from rolling fatigue)

C : Basic dynamic load rating (kN)

P_c : Radial load (kN)

f_T : Temperature factor
(see Fig.1 on **A19-13**)

f_w : Load factor
(see Table2 on **A19-13**)

* The basic dynamic load rating (C) of the Cam Follower shows the load with interlocked direction and magnitude, under which the nominal life (L) is 1 million revolutions when a group of identical Cam Follower units independently operate. The basic dynamic load rating (C) is indicated in the corresponding specification table.

[Calculating the Service Life Time]

When the nominal life (L) has been obtained, the service life time (L_h) is obtained from the following equation.

● For Linear Motion

$$L_h = \frac{D \cdot \pi \cdot L}{2 \times l_s \cdot n_1 \times 60} \quad (h)$$

L_h : Service life time (h)
 L : Nominal life (h)
 D : Bearing outer diameter (mm)
 l_s : Stroke length (mm)
 n₁ : Number of reciprocations per minute (min⁻¹)

● For Rotary Motion

$$L_h = \frac{D \cdot L}{D_1 \cdot n \times 60}$$

D₁ : Outer ring contact average diameter of the cam (mm)
 n : Revolutions per minute of the cam (min⁻¹)

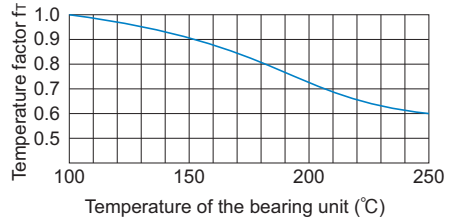

Fig.1 Temperature Factor (f_r)

Note) The normal service temperature is 80°C or below. If the product is to be used at a higher temperature, contact THK.

Table2 Load Factor (f_w)

Condition	f _w
Smooth motion without impact	1 to 1.2
Normal motion	1.2 to 1.5
Motion with severe impact	1.5 to 3

Track Load Capacity

The track load capacity means the permissible load at which the outer ring of a bearing and the mating surface are capable of withstanding repeated use over a long period.

The track load capacity provided in the specification table indicates the value when using a steel material with tensile strength of 1.24 kN/mm² as the mating material. Therefore, it is possible to increase the track load capacity by increasing the hardness of the material. Fig.2 shows the hardness of the mating material and the track capacity factor in relation to tensile strength. To obtain the track load capacity of each mating material, multiply the track load capacity shown in the corresponding specification table by the respective track load factor.

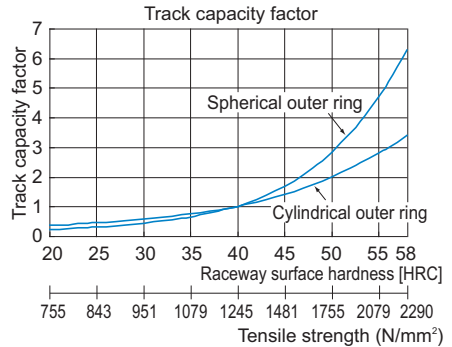

Fig.2 Track Capacity Factor

Note) For the mating material, we recommend using those materials with the raceway hardness of 20 HRC or higher and the tensile strength of 755 N/mm² or higher.

Accuracy Standards

Cam Followers are manufactured with accuracies according to Table3. However, model CFS is manufactured in accordance with Table4.

- (1) Dimensional tolerance of the cylindrical outer ring in outer diameter D : Table3
- (2) Dimensional tolerance of the spherical outer ring in outer diameter D: $\begin{matrix} 0 \\ -0.05 \end{matrix}$
- (3) Dimensional tolerance of the Cam Follower in stud diameter d : h7
- (4) Dimensional tolerance of the outer ring in width C: $\begin{matrix} 0 \\ -0.12 \end{matrix}$

Table3 Accuracy of the Outer Ring (JIS Class 0)

Unit: μm

Nominal dimension of the bearing outer diameter (D) (mm)		Tolerance of the bearing in outer diameter (Dm) ^(note)		Tolerance of the outer ring in radial runout (max)
Above	Or less	Upper	Lower	
6	18	0	-8	15
18	30	0	-9	15
30	50	0	-11	20
50	80	0	-13	25
80	120	0	-15	35

Note) "Dm" represents the arithmetic average of the maximum and minimum diameters obtained in measuring the bearing outer diameter at two points.

Table4 Accuracy standards for CFS models.

Unit: mm

(1) Dimensional tolerance for outer ring diameter D	$\begin{matrix} 0 \\ -0.008 \end{matrix}$
(2) Dimensional tolerance for stud diameter d	h6
(3) Dimensional tolerance of the outer ring in width C:	$\begin{matrix} 0 \\ -0.12 \end{matrix}$
(4) Radial runout tolerance of the outer ring	15 μm

Radial Clearance

The radial clearance of Cam Followers is based on the value indicated in Table5 (both full-roller type and caged type share the same radial clearance). The radial clearance of CFS is indicated in Table6.

Table5 Radial Clearance

Unit: μm

CF, CFN, CFH, CFT, CF-SFU	Radial Clearance (Caged type and full-roller type)	
	Min.	Max.
Stud diameter		
3 to 4	3	17
5 to 8	5	20
10 to 12-1	5	25
16 to 20-1	10	30
24 to 30-2	10	40

Table6 Radial clearance for model CFS Unit: μm

Stud diameter	Radial Clearance (Caged type and full-roller type)	
	Min.	Max.
2.5 to 5	3	17
6	5	20

Table7 Radial clearance for model NUCF Unit: μm

Stud diameter	Radial Clearance	
	Min.	Max.
16 to 24	0	25
24-1 to 30-2	5	30

Model CF-AB Cam Follower with Grease Nipple

Optional specifications		Symbol
Roller guide	With cage	No Symbol
	Full rollers	V
Material	Carbon steel	No Symbol
	Stainless steel	M
Seal	Without seal	No Symbol
	With seal	UU
Outer ring shape	Cylindrical outer ring	No Symbol
	Spherical outer ring	R

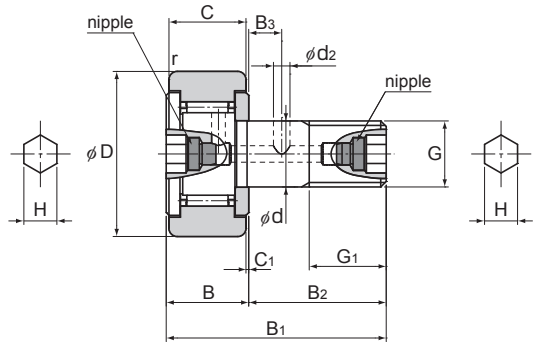

Stud diameter	Model No.	Main dimensions												
		Outer diameter	Outer ring width	Threaded			Overall length						Shoulder height f (Min.)	
d		D	C	G	G ₁	B	B ₁	B ₂	B ₃	C ₁	d ₂	H	r _{min}	
12	CF 12-AB	30	14	M12×1.5	13	15	40	25	6	0.6	3	6	0.6	20
12	CF 12-1-AB	32	14	M12×1.5	13	15	40	25	6	0.6	3	6	0.6	20
16	CF 16-AB	35	18	M16×1.5	17	19.5	52	32.5	8	0.8	3	6	0.6	24
18	CF 18-AB	40	20	M18×1.5	19	21.5	58	36.5	8	0.8	3	6	1	26
20	CF 20-AB	52	24	M20×1.5	21	25.5	66	40.5	9	0.8	4	8	1	36
20	CF 20-1-AB	47	24	M20×1.5	21	25.5	66	40.5	9	0.8	4	8	1	36
24	CF 24-AB	62	29	M24×1.5	25	30.5	80	49.5	11	0.8	4	8	1	40
24	CF 24-1-AB	72	29	M24×1.5	25	30.5	80	49.5	11	0.8	4	8	1	40
30	CF 30-AB	80	35	M30×1.5	32	37	100	63	15	1	4	8	1	46
30	CF 30-1-AB	85	35	M30×1.5	32	37	100	63	15	1	4	8	1	46
30	CF 30-2-AB	90	35	M30×1.5	32	37	100	63	15	1	4	8	1	46

Note) For information on accuracy standards, please refer to **A19-14**.

Model number coding

CF12 V M UU R -AB

Model No.

Stud With Hexagonal Socket At Both Ends

No symbol: With cage

No Symbol : Cylindrical outer ring

V : Full-roller Type

R : Spherical outer ring

No symbol: Carbon steel

No symbol: Without seal

M : Stainless steel

UU : With seal

Note) For accessories, see **A19-38**.

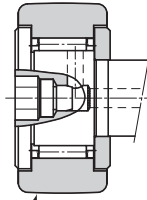

R500 (CF12 to CF18)
R1000 (CF20 or higher)

Model CF-R-AB

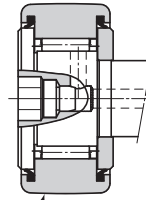

R500 (CF12 to CF18)
R1000 (CF20 or higher)

Model CF-UUR-AB

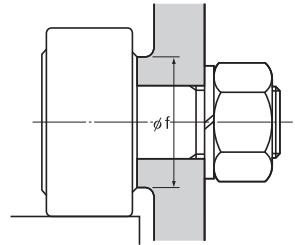

Unit: mm

	Basic Load Rating				Maximum permissible load F_0 kN	Track Load Capacity		Rotational speed limit *		Mass	
	With cage		Full rollers			Cylindrical outer ring kN	Spherical outer ring kN	With cage min^{-1}	Full rollers min^{-1}	With cage g	Full rollers g
	C kN	C_0 kN	C kN	C_0 kN							
	7.87	9.79	13.4	19.8	9.37	7.06	2.45	14000	5800	105	107
	7.87	9.79	13.4	19.8	9.37	7.45	2.74	14000	5800	115	117
	12	18.3	20.6	37.6	17.3	11.2	3.14	10000	4500	205	207
	14.7	25.2	25.2	51.3	26.1	14.4	3.72	8500	3800	295	300
	20.7	34.8	33.2	64.8	32.1	23.2	8.23	7000	3400	525	530
	20.7	34.8	33.2	64.8	32.1	21	7.15	7000	3400	450	455
	30.6	53.2	46.7	92.9	49.5	34.2	10.5	6500	2900	915	925
	30.6	53.2	46.7	92.9	49.5	39.8	12.9	6500	2900	1150	1160
	45.4	87.6	67.6	145	73.7	52.6	14.9	5000	2300	1880	1890
	45.4	87.6	67.6	145	73.7	56	16.1	5000	2300	1950	1960
	45.4	87.6	67.6	145	73.7	59.3	17.3	5000	2300	2000	2010

Note) The rotation speed limit value in the table (*) applies to models that have no seal and use grease lubrication. With those models using oil lubrication, up to 130% of this value is permitted. With those attached with seals, up to 70% of this value is permitted.

Model CF (Popular Type)

Optional specifications		Symbol
Roller guide	With cage	No Symbol
	Full rollers	V
Material	Carbon steel	No Symbol
	Stainless steel	M
Seal	Without seal	No Symbol
	With seal	UU
Outer ring shape	Cylindrical outer ring	No Symbol
	Spherical outer ring	R

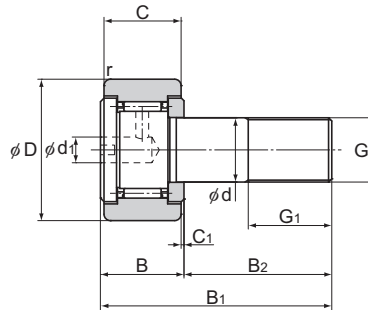

Stud diameter	Model No.	Main dimensions										
		Outer diameter	Outer ring width	Threaded			Overall length					Shoulder height f (Min.)
d		D	C	G	G ₁	B	B ₁	B ₂	C ₁	d ₁	r _{min}	
5	CF 5	13	9	M5×0.8	7.5	10	23	13	0.5	3.1	0.3	9.7
6	CF 6	16	11	M6×1	8	12	28	16	0.6	4	0.3	11
8	CF 8	19	11	M8×1.25	10	12	32	20	0.6	4	0.3	13
10	CF 10	22	12	M10×1.25	12	13	36	23	0.6	4	0.3	15
10	CF 10-1	26	12	M10×1.25	12	13	36	23	0.6	4	0.3	15

Note) For information on accuracy standards, please refer to **A19-14**.

Model number coding

CF6 V M UU R -N

Model No.

No symbol: With cage
V : Full-roller Type

No symbol: Carbon steel
M : Stainless steel

no symbol: without seal
UU : With seal

No symbol: No grease nipple

N : Dedicated grease nipple included (See **A19-39**)

No Symbol: Cylindrical outer ring
R : Spherical outer ring

Note) Full-roller Type is applicable for Stud Diameter 6 to 10.

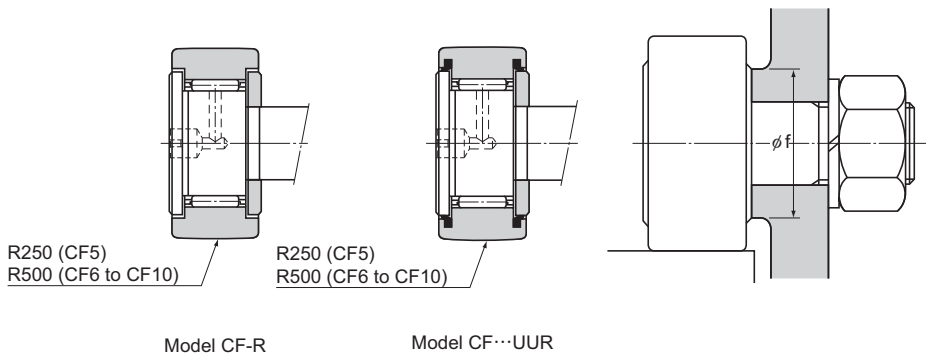

	Basic load rating				Maximum permissible load F_0 kN	Track load capacity		Rotational speed limit *		Mass	
	With cage		Full rollers			Cylindrical outer ring kN	Spherical outer ring kN	With cage min^{-1}	Full rollers min^{-1}	With cage g	Full rollers g
	C kN	C_0 kN	C kN	C_0 kN							
	3.14	2.77	—	—	1.42	2.25	0.53	29000	—	10.5	—
	3.59	3.58	6.94	8.5	2.11	3.43	1.08	25000	11000	18.5	19
	4.17	4.65	8.13	11.2	4.73	4.02	1.37	20000	8700	28.5	29
	5.33	6.78	9.42	14.3	5.81	4.7	1.67	17000	7200	45	46
	5.33	6.78	9.42	14.3	5.81	5.49	2.06	17000	7200	60	61

Note) The rotation speed limit value in the table (*) applies to models that have no seal and use grease lubrication. With those models using oil lubrication, up to 130% of this value is permitted. With those attached with seals, up to 70% of this value is permitted.

Cam Follower with Hexagon Socket Model CF-A

Optional specifications		Symbol
Roller guide	With cage	No Symbol
	Full rollers	V
Material	Carbon steel	No Symbol
	Stainless steel	M
Seal	Without seal	No Symbol
	With seal	UU
Outer ring shape	Cylindrical outer ring	No Symbol
	Spherical outer ring	R

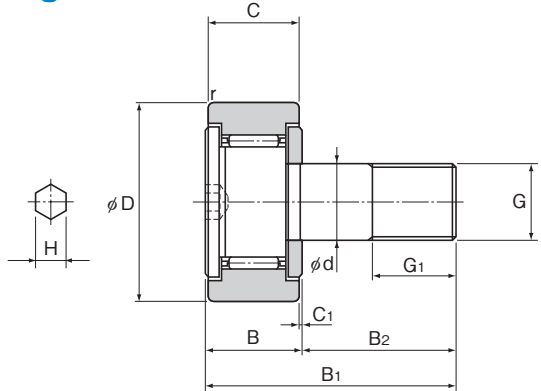

Stud diameter	Model No.	Main dimensions										
		Outer diameter	Outer ring width	Threaded			Overall length					Shoulder height f (Min.)
d		D	C	G	G ₁	B	B ₁	B ₂	C ₁	H*	r _{min}	
3	CF 3-A	10	7	M3×0.5	5	8	17	9	0.5	2 (1.5)	0.2	6.8
4	CF 4-A	12	8	M4×0.7	6	9	20	11	0.5	2.5 (2)	0.3	8.6
5	CF 5-A	13	9	M5×0.8	7.5	10	23	13	0.5	3 (2.5)	0.3	9.7
6	CF 6-A	16	11	M6×1	8	12	28	16	0.6	3	0.3	11
8	CF 8-A	19	11	M8×1.25	10	12	32	20	0.6	4	0.3	13
10	CF 10-A	22	12	M10×1.25	12	13	36	23	0.6	5	0.3	15
10	CF 10-1-A	26	12	M10×1.25	12	13	36	23	0.6	5	0.3	15

Note) For information on accuracy standards, please refer to **A19-14**.
Those models do not have a greasing hole and cannot be replenished with grease.

Model number coding

CF10 V M UU R -A N

Model No.

No symbol: With cage

V : Full-roller Type

No symbol: Carbon steel

M : Stainless steel

no symbol: without seal

UU : With seal

No Symbol: Cylindrical outer ring

R : Spherical outer ring

Stud head with a hexagon socket

No symbol: No grease nipple

N : Dedicated grease nipple included (see **A19-39**)

Note) Full-roller Type is applicable for Stud Diameter 6 to 10.

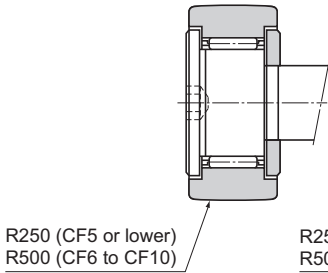

Model CF-R-A

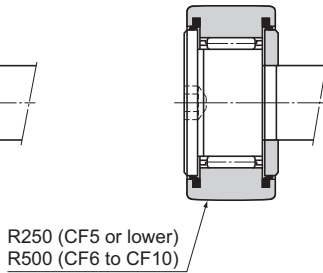

Model CF...UUR-A

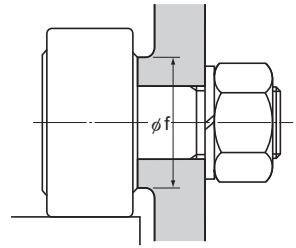

Unit: mm

	Basic load rating				Maximum permissible load F_0 kN	Track load capacity		Rotational speed limit *		Mass	
	With cage		Full rollers			Cylindrical outer ring kN	Spherical outer ring kN	With cage min^{-1}	Full rollers min^{-1}	With cage g	Full rollers g
	C kN	C_0 kN	C kN	C_0 kN							
	1.47	1.18	—	—	0.36	1.37	0.37	47000	—	4.5	—
	2.06	2.05	—	—	0.78	1.76	0.47	37000	—	7.5	—
	3.14	2.77	—	—	1.42	2.25	0.53	29000	—	10.5	—
	3.59	3.58	6.94	8.5	2.11	3.43	1.08	25000	11000	18.5	19
	4.17	4.65	8.13	11.2	4.73	4.02	1.37	20000	8700	28.5	29
	5.33	6.78	9.42	14.3	5.81	4.7	1.67	17000	7200	45	46
	5.33	6.78	9.42	14.3	5.81	5.49	2.06	17000	7200	60	61

Note1)★ indicates that the dimensions in the parentheses in this row apply to stainless steel types.

The rotation speed limit value in the table (*) applies to models that have no seal and use grease lubrication. With those models using oil lubrication, up to 130% of this value is permitted. With those attached with seals, up to 70% of this value is permitted.

Eccentric Cam Follower with Grease Nipple Model CFH-AB

Optional specifications		Symbol
Roller guide	With cage	No Symbol
	Full rollers	V
Material	Carbon steel	No Symbol
	Stainless steel	M
Seal	Without seal	No Symbol
	With seal	UU
Outer ring shape	Cylindrical outer ring	No Symbol
	Spherical outer ring	R

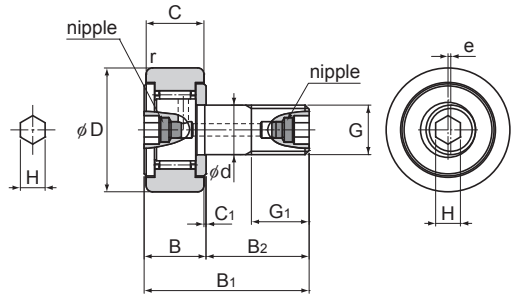

Stud diameter d	Model No.	Main dimensions											
		Outer diameter D	Outer ring width C	Threaded G	G ₁	B	B ₁	B ₂	C ₁	Runout e	H	r _{amin}	Shoulder height f (Min.)
12	CFH 12-AB	30	14	M12×1.5	13	15	40	25	0.6	0.4	6	0.6	20
12	CFH 12-1-AB	32	14	M12×1.5	13	15	40	25	0.6	0.4	6	0.6	20
16	CFH 16-AB	35	18	M16×1.5	17	19.5	52	32.5	0.8	0.5	6	0.6	24
18	CFH 18-AB	40	20	M18×1.5	19	21.5	58	36.5	0.8	0.6	6	1	26
20	CFH 20-AB	52	24	M20×1.5	21	25.5	66	40.5	0.8	0.7	8	1	36
20	CFH 20-1-AB	47	24	M20×1.5	21	25.5	66	40.5	0.8	0.7	8	1	36
24	CFH 24-AB	62	29	M24×1.5	25	30.5	80	49.5	0.8	0.8	8	1	40
24	CFH 24-1-AB	72	29	M24×1.5	25	30.5	80	49.5	0.8	0.8	8	1	40
30	CFH 30-AB	80	35	M30×1.5	32	37	100	63	1	1	8	1	46
30	CFH 30-1-AB	85	35	M30×1.5	32	37	100	63	1	1	8	1	46
30	CFH 30-2-AB	90	35	M30×1.5	32	37	100	63	1	1	8	1	46

Note) For information on accuracy standards, please refer to **A19-14**.

Model number coding

CFH12 V M UU R -AB

Model No.

No symbol: With cage
V : Full-roller Type

No symbol: Carbon steel
M : Stainless steel

No symbol: Without seal
UU : With seal

Stud With Hexagonal Socket At Both Ends

No Symbol : Cylindrical outer ring
R : Spherical outer ring

Note) For accessories, see **A19-38**.

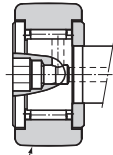

R500 (CFH18 or lower)
R1000 (CFH20 or higher)

Model CFH-R-AB

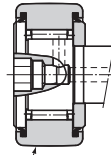

R500 (CFH18 or lower)
R1000 (CFH20 or higher)

Model CFH-UUR-AB

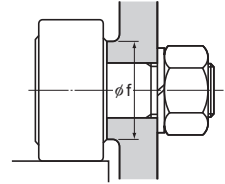

Unit: mm

	Basic Load Rating				Maximum permissible load F_0 kN	Track load capacity		Rotational speed limit *		Mass	
	With cage		Full rollers			Cylindrical outer ring kN	Spherical outer ring kN	With cage min^{-1}	Full rollers min^{-1}	With cage g	Full rollers g
	C kN	C_0 kN	C kN	C_0 kN							
	7.87	9.79	13.4	19.8	9.37	7.06	2.45	14000	5800	105	107
	7.87	9.79	13.4	19.8	9.37	7.45	2.74	14000	5800	115	117
	12	18.3	20.6	37.6	17.3	11.2	3.14	10000	4500	205	207
	14.7	25.2	25.2	51.3	26.1	14.4	3.72	8500	3800	295	300
	20.7	34.8	33.2	64.8	32.1	23.2	8.23	7000	3400	525	530
	20.7	34.8	33.2	64.8	32.1	21	7.15	7000	3400	450	455
	30.6	53.2	46.7	92.9	49.5	34.2	10.5	6500	2900	915	925
	30.6	53.2	46.7	92.9	49.5	39.8	12.9	6500	2900	1150	1160
	45.4	87.6	67.6	145	73.7	52.6	14.9	5000	2300	1880	1890
	45.4	87.6	67.6	145	73.7	56	16.1	5000	2300	1950	1960
	45.4	87.6	67.6	145	73.7	59.3	17.3	5000	2300	2000	2010

Note) The rotation speed limit value in the table (*) applies to models that have no seal and use grease lubrication. With those models using oil lubrication, up to 130% of this value is permitted. With those attached with seals, up to 70% of this value is permitted.

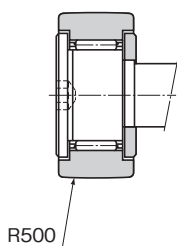

Model CFH-R

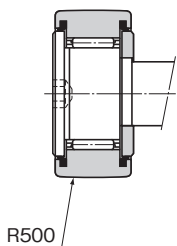

Model CFH...UUR

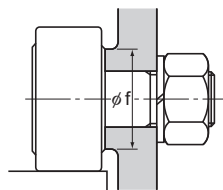

Unit: mm

	Basic load rating				Maximum permissible load F_0 kN	Track load capacity		Rotational speed limit *		Mass	
	With cage		Full rollers			Cylindrical outer ring kN	Spherical outer ring kN	With cage min^{-1}	Full rollers min^{-1}	With cage g	Full rollers g
	C kN	C_0 kN	C kN	C_0 kN							
	3.14	2.77	—	—	1.42	2.25	0.53	29000	—	10.5	—
	3.59	3.58	6.94	8.5	2.11	3.43	1.08	25000	11000	18.5	19
	4.17	4.65	8.13	11.2	4.73	4.02	1.37	20000	8700	28.5	29
	5.33	6.78	9.42	14.3	5.81	4.7	1.67	17000	7200	45	46
	5.33	6.78	9.42	14.3	5.81	5.49	2.06	17000	7200	60	61

Note1) \odot : Model CFH5M-A is available only in carbon steel.

Note2) The rotation speed limit value in the table (*) applies to models that have no seal and use grease lubrication. With those models using oil lubrication, up to 130% of this value is permitted. With those attached with seals, up to 70% of this value is permitted.

Cam Follower Containing Thrust Balls Model CFN-R-A

Optional specifications		Symbol
Roller guide	With cage	No Symbol
Material	Carbon steel	No Symbol
Seal	Without seal	No Symbol
Outer ring shape	Spherical outer ring	R

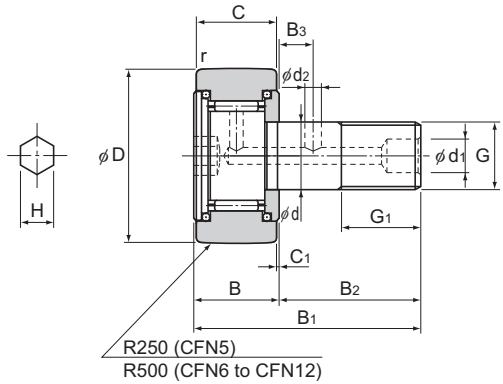

Stud diameter d	Model No. Spherical outer ring	Main									
		Outer diameter D	Outer ring width C	Threaded G	G ₁	B	Overall length B ₁ B ₂		B ₃	C ₁	d ₁
5	CFN 5R-A	13	9	M5×0.8	7.5	10	23	13	—	0.5	—*
6	CFN 6R-A	16	11	M6×1	8	12	28	16	—	0.6	—*
8	CFN 8R-A	19	11	M8×1.25	10	12	32	20	—	0.6	—*
10	CFN 10R-A	22	12	M10×1.25	12	13	36	23	—	0.6	—*
12	CFN 12R-A	30	14	M12×1.5	13	15	40	25	6	0.6	6

Note) For information on accuracy standards, please refer to **A19-14**.

Those models marked with "*" do not have a greasing hole and cannot be replenished with grease.

Model number coding

CFN12 R -A N

Model No.

R : Spherical outer ring

No Symbol : No grease nipple

N : Dedicated grease nipple included (See **A19-39**)

Stud head with a hexagon socket

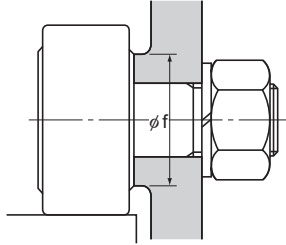

Unit: mm

dimensions					Basic load rating		Permissible thrust load	Maximum permissible load F_0	Track load capacity	Rotational speed limit *	Mass
d_2	H	r_{amin}	Shoulder height f (Min.)	C kN	C_0 kN	N					
—*	3	0.3	10	3.14	2.77	160	1.42	0.53	29000	10.5	
—*	3	0.3	12	3.59	3.58	250	2.11	1.08	25000	18.5	
—*	4	0.3	14	4.17	4.65	290	4.73	1.37	20000	28.5	
—*	5	0.3	16.5	5.33	6.78	400	5.81	1.67	17000	45	
3	6	0.6	21.5	7.87	9.79	680	9.37	2.45	14000	105	

Note) The rotation speed limit value in the table (*) applies to models using grease lubrication. With those models using oil lubrication, up to 130% of this value is permitted.

Cam Follower with Tapped Greasing Hole Model CFT

Optional specifications		Symbol
Roller guide	With cage	No Symbol
	Full rollers	V
Material	Carbon steel	No Symbol
	Stainless steel	M
Seal	Without seal	No Symbol
	With seal	UU
Outer ring shape	Cylindrical outer ring	No Symbol
	Spherical outer ring	R

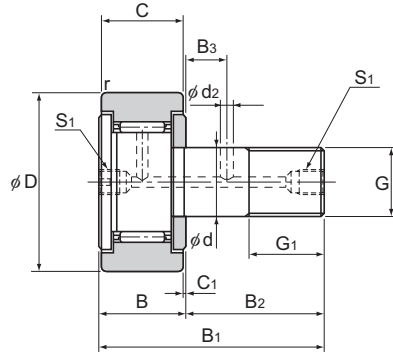

Stud diameter	Model No.	Main dimensions												
		Outer diameter	Outer ring width	Threaded			Overall length						Shoulder height	
d		D	C	G	G ₁	B	B ₁	B ₂	B ₃	C ₁	S ₁	d ₂	r _{min}	f (Min.)
6	CFT 6	16	11	M6×1	8	12	28	16	—	0.6	M6×0.75*	—	0.3	11
8	CFT 8	19	11	M8×1.25	10	12	32	20	—	0.6	M6×0.75*	—	0.3	13
10	CFT 10	22	12	M10×1.25	12	13	36	23	—	0.6	M6×0.75*	—	0.3	15
10	CFT 10-1	26	12	M10×1.25	12	13	36	23	—	0.6	M6×0.75*	—	0.3	15
12	CFT 12	30	14	M12×1.5	13	15	40	25	6	0.6	M6×0.75	3	0.6	20
12	CFT 12-1	32	14	M12×1.5	13	15	40	25	6	0.6	M6×0.75	3	0.6	20
16	CFT 16	35	18	M16×1.5	17	19.5	52	32.5	8	0.8	PT 1/8	3	0.6	24
18	CFT 18	40	20	M18×1.5	19	21.5	58	36.5	8	0.8	PT 1/8	3	1	26
20	CFT 20	52	24	M20×1.5	21	25.5	66	40.5	9	0.8	PT 1/8	4	1	36
20	CFT 20-1	47	24	M20×1.5	21	25.5	66	40.5	9	0.8	PT 1/8	4	1	36
24	CFT 24	62	29	M24×1.5	25	30.5	80	49.5	11	0.8	PT 1/8	4	1	40
24	CFT 24-1	72	29	M24×1.5	25	30.5	80	49.5	11	0.8	PT 1/8	4	1	40
30	CFT 30	80	35	M30×1.5	32	37	100	63	15	1	PT 1/8	4	1	46
30	CFT 30-1	85	35	M30×1.5	32	37	100	63	15	1	PT 1/8	4	1	46
30	CFT 30-2	90	35	M30×1.5	32	37	100	63	15	1	PT 1/8	4	1	46

Note) For information on accuracy standards, please refer to **A19-14**.
Those models marked with "*" have a greasing hole only on the head.

Model number coding

CFT30-1 V M UU R -N

Model No.

No symbol: With cage

V : Full-roller Type

No symbol: Carbon steel

M : Stainless steel

No symbol: Without seal

UU : With seal

No Symbol : No grease nipple

N : Dedicated grease nipple included (See **A19-39**)

No Symbol: Cylindrical outer ring

R : Spherical outer ring

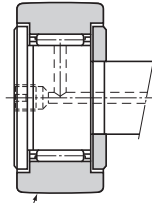

R500 (CFT18 or lower)
R1000 (CFT20 or higher)

Model CFT-R

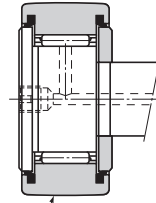

R500 (CFT18 or lower)
R1000 (CFT20 or higher)

Model CFT...UUR

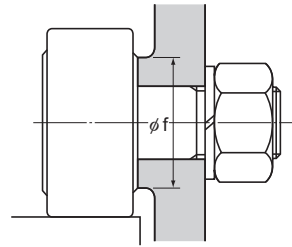

Unit: mm

	Basic load rating				Maximum permissible load F_0 kN	Track load capacity		Rotational speed limit *		Mass	
	With cage		Full rollers			Cylindrical outer ring kN	Spherical outer ring kN	With cage min^{-1}	Full rollers min^{-1}	With cage g	Full rollers g
	C kN	C_0 kN	C kN	C_0 kN							
	3.59	3.58	6.94	8.5	2.11	3.43	1.08	25000	11000	18.5	19
	4.17	4.65	8.13	11.2	4.73	4.02	1.37	20000	8700	28.5	29
	5.33	6.78	9.42	14.3	5.81	4.7	1.67	17000	7200	45	46
	5.33	6.78	9.42	14.3	5.81	5.49	2.06	17000	7200	60	61
	7.87	9.79	13.4	19.8	9.37	7.06	2.45	14000	5800	105	107
	7.87	9.79	13.4	19.8	9.37	7.45	2.74	14000	5800	115	117
	12	18.3	20.6	37.6	17.3	11.2	3.14	10000	4500	205	207
	14.7	25.2	25.2	51.3	26.1	14.4	3.72	8500	3800	295	300
	20.7	34.8	33.2	64.8	32.1	23.2	8.23	7000	3400	525	530
	20.7	34.8	33.2	64.8	32.1	21	7.15	7000	3400	450	455
	30.6	53.2	46.7	92.9	49.5	34.2	10.5	6500	2900	915	925
	30.6	53.2	46.7	92.9	49.5	39.8	12.9	6500	2900	1150	1160
	45.4	87.6	67.6	145	73.7	52.6	14.9	5000	2300	1880	1890
	45.4	87.6	67.6	145	73.7	56	16.1	5000	2300	1950	1960
	45.4	87.6	67.6	145	73.7	59.3	17.3	5000	2300	2000	2010

Note) The rotation speed limit value in the table (*) applies to models that have no seal and use grease lubrication. With those models using oil lubrication, up to 130% of this value is permitted. With those attached with seals, up to 70% of this value is permitted.

Outer-ring Compact-type Cam Follower Model CFS-A

Optional specifications		Symbol
Roller guide	With cage	No Symbol
	Full rollers	V
Material	Carbon steel	No Symbol
	Stainless steel	M
Seal	Without seal	No Symbol
Outer ring shape	Cylindrical outer ring	No Symbol

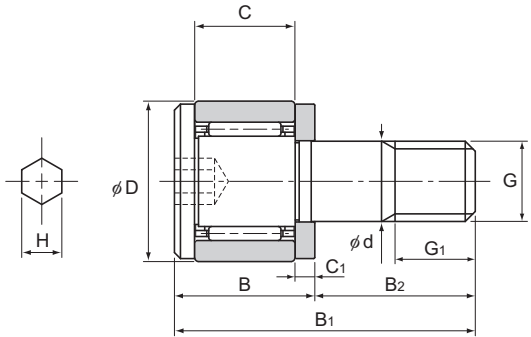

Stud diameter	Model No.	Main dimensions									
		Outer diameter	Outer ring width	Threaded			Overall length				Shoulder height
d		D	C	G	G ₁	B	B ₁	B ₂	C ₁	H	f (Min.)
2.5	CFS 2.5-A	5	3	M2.5×0.45	2.5	4.5	9.5	5	0.7	0.9	4.8
3	CFS 3-A	6	4	M3×0.5	3	5.5	11.5	6	0.7	1.5	5.8
4	CFS 4-A	8	5	M4×0.7	4	7	15	8	1	2	7.7
5	CFS 5-A	10	6	M5×0.8	5	8	18	10	1	2.5	9.6
6	CFS 6-A	12	7	M6×1.0	6	9.5	21.5	12	1.2	3	11.6

Note) For information on accuracy standards, please refer to **A19-14**.

Model number coding

CFS3 V M -A

Model No.

No symbol: With cage

V : Full-roller Type

No symbol: Carbon steel

M : Stainless steel

Stud head with a hexagon socket

Note) Model CFS is only compatible with cylindrical outer ring types without seals and with stud head hexagon sockets.

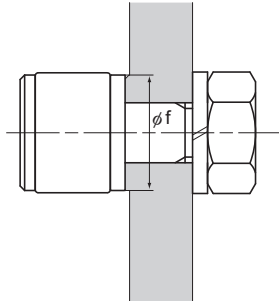

Unit: mm

	Basic load rating				Maximum permissible load F_0 kN	Track load capacity Cylindrical outer ring kN	Mass	
	With cage		Full rollers				With cage	Full rollers
	C kN	C_0 kN	C kN	C_0 kN		g	g	
	0.41	0.335	1	1.08	0.26	0.3	1	1
	0.63	0.61	1.37	1.77	0.36	0.48	2	2
	1.08	1.08	2.35	3.04	0.78	0.77	4	4
	1.57	1.86	3.14	4.71	1.42	1.18	7	7
	2.06	2.16	4.61	6.27	2.11	1.54	13	13

* Since model CFS does not have a greasing hole, it cannot be replenished with grease.

Easy-mount Cam Follower Model CF-SFU

Optional specifications		Symbol
Roller guide	With cage	No Symbol
Material	Carbon steel	No Symbol
Seal	With seal	No Symbol
Outer ring shape	Cylindrical outer ring	No Symbol
	Spherical outer ring	R

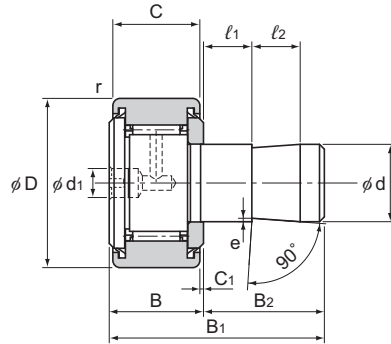

Stud diameter	Model No.	Main dimensions										
		Outer diameter	Outer ring width		Overall length							
d		D	C	B	B ₁	B ₂	C ₁	l ₁	l ₂	d ₁	r _{smn}	e
6	CF-SFU-6	16	11	12	32	20	0.6	5	10	4	0.3	0.3
8	CF-SFU-8	19	11	12	32	20	0.6	5	10	4	0.3	0.5
10	CF-SFU-10	22	12	13	33	20	0.6	5	10	4	0.3	0.5
10	CF-SFU-10-1	26	12	13	33	20	0.6	5	10	4	0.3	0.5
12	CF-SFU-12	30	14	15	35	20	0.6	5	10	6	0.6	1
12	CF-SFU-12-1	32	14	15	35	20	0.6	5	10	6	0.6	1
16	CF-SFU-16	35	18	19.5	44.5	25	0.8	10	10	6	0.6	1
18	CF-SFU-18	40	20	21.5	46.5	25	0.8	10	10	6	1	1
20	CF-SFU-20	52	24	25.5	50.5	25	0.8	10	10	8	1	1
20	CF-SFU-20-1	47	24	25.5	50.5	25	0.8	10	10	8	1	1

Note) For information on accuracy standards, please refer to **A19-14**.

Model number coding

CF-SFU-6 R -N

Model No.

No Symbol : Cylindrical outer ring
R : Spherical outer ring

No Symbol : No grease nipple

N : Dedicated grease nipple included (See **A19-39**)

Note) Model CF-SFU is fitted with UU seals even where no UU symbol is used.

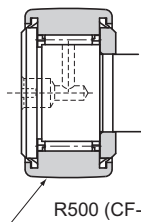

R500 (CF-SFU-6 to CF-SFU-18)
R1000 (CF-SFU-20 or higher)

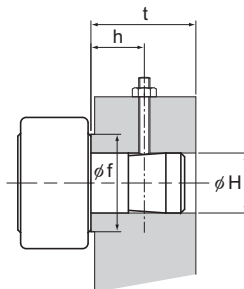

Model CF-SFU...R

Unit: mm

	Mounting dimensions				Basic load rating		Maximum permissible load F_0 kN	Track load capacity		Rotational speed limit *	Mass
	Mounting dimension H Tolerance H7	t (Min.)	Shoulder height f (Min.)	h (reference value)	With cage			Cylindrical outer ring kN	Spherical outer ring kN	With cage min^{-1}	With cage g
					C kN	C_0 kN					
	6	20	11	10	3.59	3.58	2.11	3.43	1.08	17500	19
	8	20	13	10	4.17	4.65	4.73	4.02	1.37	14000	28.5
	10	20	15	10	5.33	6.78	5.81	4.7	1.67	11900	43
	10	20	15	10	5.33	6.78	5.81	5.49	2.06	11900	58.5
	12	20	20	10	7.87	9.79	9.37	7.06	2.45	9800	93
	12	20	20	10	7.87	9.79	9.37	7.45	2.74	9800	103
	16	25	24	15	12	18.3	17.3	11.2	3.14	7000	163.5
	18	25	26	15	14.7	25.2	26.1	14.4	3.72	5950	235
	20	25	36	15	20.7	34.8	32.1	23.2	8.23	4900	436
	20	25	36	15	20.7	34.8	32.1	21	7.15	4900	361

Note) *The rotational speed limit applies to models with grease lubrication and seals.
Model CF-SFU is delivered with a stopper plug fitted.

Double-row Cylindrical-roller Cam Follower Model NUCF-AB

Optional specifications		Symbol
Roller guide	Full rollers	No Symbol
Material	Carbon steel	No Symbol
Seal	Without seal	No Symbol
Outer ring shape	Cylindrical outer ring	No Symbol
	Spherical outer ring	R

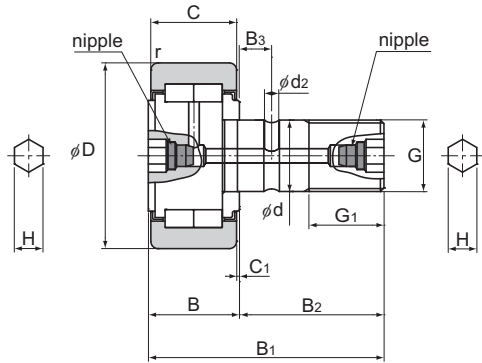

Stud diameter	Model No.	Main dimensions												Shoulder height f (Min.)
		Outer diameter D	Outer ring width C	Threaded G	G ₁	B	Overall length B ₁	B ₂	B ₃	C ₁	d ₂	H	r _{min}	
16	NUCF 16-AB	35	18	M16×1.5	17	19.5	52	32.5	7.8	0.8	3	6	0.6	20
18	NUCF 18-AB	40	20	M18×1.5	19	21.5	58	36.5	8	0.8	3	6	1	22
20	NUCF 20-AB	52	24	M20×1.5	21	25.5	66	40.5	9	0.8	4	8	1	31
20	NUCF 20-1-AB	47	24	M20×1.5	21	25.5	66	40.5	9	0.8	4	8	1	27
24	NUCF 24-AB	62	28	M24×1.5	25	30.5	80	49.5	11	1.3	4	8	1	38
24	NUCF 24-1-AB	72	28	M24×1.5	25	30.5	80	49.5	11	1.3	4	8	1.1	44
30	NUCF 30-AB	80	35	M30×1.5	32	37	100	63	15	1	4	8	1.1	47
30	NUCF 30-2-AB	90	35	M30×1.5	32	37	100	63	15	1	4	8	1.1	47

Note) For information on accuracy standards, please refer to **A19-14**.

Model number coding

NUCF16 R -AB

Model No.

AB: Stud With Hexagonal Socket At Both Ends

No Symbol: Cylindrical outer ring

R : Spherical outer ring

Note) For accessories, see **A19-38**.

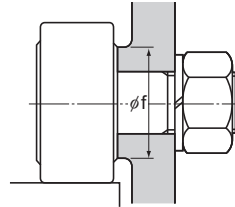
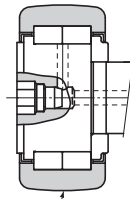

R500 (NUCF18 or lower)
R1000 (NUCF20 or higher)

Unit: mm

	Basic load rating		Maximum permissible load	Track load capacity		Rotational speed limit	Mass
				Cylindrical outer ring	Spherical outer ring		
	C kN	C ₀ kN		F ₀ kN	kN		
	23.4	27.2	11.5	11.2	3.14	5200	200
	25.2	30.9	21.2	14.4	3.72	4700	295
	43	58.1	27.1	23.2	8.23	3300	515
	38.9	48.9	24.8	21	7.15	3800	445
	57.6	74.3	34.3	32.9	10.5	2800	885
	63.3	87.5	49.5	38.2	12.9	2300	1120
	94.8	135	73.7	52.6	14.9	2100	1840
	94.8	135	73.7	59.3	17.3	2100	2200

Fit

For the dimensional tolerance of the Cam Follower in stud-mounting hole, we recommend the following fitting.

Table1 The dimensional tolerance of the stud-mounting hole

Model No.	The dimensional tolerance of the stud-mounting hole
Models CF, CFN, CFH, CFT, CF-SFU and NUCF	H7
Model CFS	H6

Installation

[Mounting Section]

Establish perpendicularity between the stud-mounting hole and the mounting surface, and chamfer the mouth of the hole to the smallest possible radius, preferably C0.5. Also, the diameter of the mounting surface should preferably be at least equal to the dimension “f” indicated in the specification table.

If the outer ring unilaterally or unevenly contacts the mating raceway, we recommend using model CF-R, whose outer ring circumference is spherically ground.

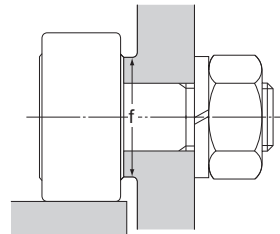

[Mating Raceway]

For the material of the mating raceway, see Track Load Capacity on **A19-13**.

[Mounting Precautions]

Do not tap the bracket and directly tighten the product without using a nut as shown in Fig.1. Doing so may result in an insufficient tightening torque, or cause the bending stress to concentrate in the male thread and damage the stud if the thread is loosened.

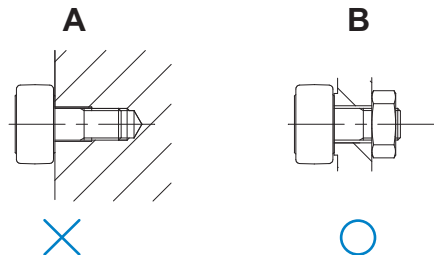

Fig.1

[Mounting model CF-SFU]

Refer to Fig.2 for information on how to mount CF-SFU models.

To the extent that CF-SFU models are designed for easy mounting and are therefore easy to remove, they are not suitable for uses where the loads applied are vibrating or involve impacts. For vibrating or impact loads, a normal cam follower secured by a nut is recommended.

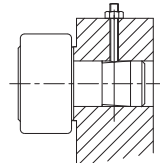

Fig.2

Cam Follower Accessories

The standard cam follower accessories are shown in Table1.

The stopper plug is used to prevent grease from leaking out. The filler plug is used to seal an unused oil hole. Both must be used with care: once inserted, they cannot be removed. Use either of these two items, in accordance with the intended application, when not using a grease nipple.

Table1 Accessories

Model number	Stud diameter(mm)	Stopper plug	Filler plug	Nut JIS Class 2	Grease
CF-AB		—	—	Included	Filled
CF	5	—	—	Included	Filled
	6 or larger	Included	—	Included	Filled
CF-A		—	—	Included	Filled
CFH-AB		—	—	Included	Filled
CFH-A		—	—	Included	Filled
CFN-A	10 or smaller	—	—	Included	Filled
	12	Included	Included	Included	Filled
CFT		—	— ^{Note1)}	Included	Filled
CFS		—	—	Included	Filled
CF-SFU	10 or smaller	Mounting bolt	—	—	Filled
	12 or larger	Mounting bolt	Included	—	Filled
NUCF-AB		—	—	Included	Filled

Note1) If a plug for model CFT is required, please contact THK.

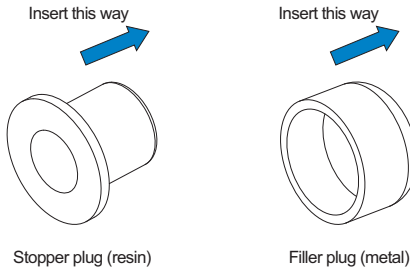

Grease nipple

If a grease nipple is required, please add the symbol "N" to the end of the part number. The grease nipple shown in Table2 will be attached. When ordering the model CFT, indicate which type of grease nipple is to be attached.

The attachment for the grease gun unit MG70 varies according to the cam follower model, as shown in Table2.

For the size and shape of each grease nipple, see **A24-24** to **A24-26**.

Example: CF 10 UUR -N

 Dedicated grease nipple

Table2 Grease nipple correspondence table

Model number Stud diameter(mm)		Nipple	Attachment Type
CF-AB		Embedded ^{Note1)}	Type P
CF	5	NP3.2×3.5	Type N
	6 or more	PB1021B	Type N
CF-A		— ^{Note2)}	—
CFH-AB		Embedded ^{Note1)}	Type P
CFH-A		— ^{Note2)}	—
CFN-A	10 or less	— ^{Note2)}	—
	12	NP6×5	Type N
CFT	12 or less	A-M6F,B-M6F,C-M6F	Type H
	16 or more	A-PT1/8,B-PT1/8,C-PT1/8	Type H
CFS		— ^{Note2)}	—
CF-SFU	6 to 10	PB1021B	Type N
	12 to 18	NP6×5	Type N
	20	NP8×9	Type N
NUCF-AB		Embedded ^{Note1)}	Type P

Note1)CF(H)-AB and NUCF-AB models are pre-fitted with grease nipples. These models come with grease nipples attached even if "N" is not added to the model number when ordering.

Note2) Cannot re-grease

Model Number Coding

Model number configurations differ depending on the model features. Refer to the corresponding sample model number configuration.

[Cam Follower with Grease Nipple]

● Models CF-AB, CFH-AB and NUCF-AB

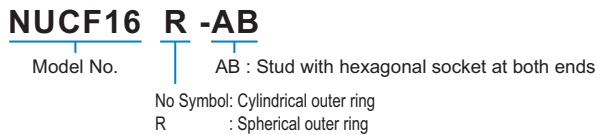
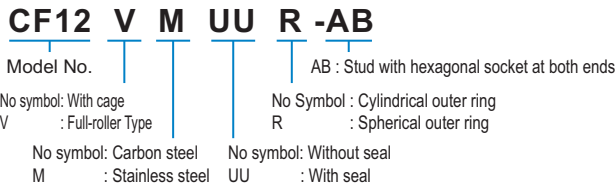

[Cam Follower]

● Models CF, CFH, CFN, CFT and CFS

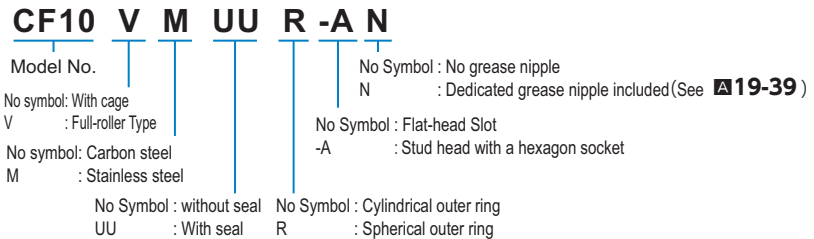

* Because support will vary depending on the model number, please refer to each dimensional table for details.

[Easy-mount Cam Follower]

● Models CF-SFU and CF-SFU-R

CF-SFU-6 R

No Symbol: Cylindrical outer ring
R : Spherical outer ring

* CF-SFU models are fitted with UU seals even where no UU symbol is used.

[Handling]

- (1) Do not disassemble the parts. This will result in loss of functionality.
- (2) Take care not to drop or strike the Cam Follower. Doing so may cause injury or damage. Giving an impact to it could also cause damage to its function even if the product looks intact.
- (3) When handling the product, wear protective gloves, safety shoes, etc., as necessary to ensure safety.

[Precautions on Use]

- (1) Use a torque wrench or a similar tool to tighten the nut when installing the Cam Follower, using the appropriate fastening torque set forth in **■19-16** on Table1.
- (2) Do not use the product at temperature of 80°C or higher. Exposure to higher temperatures may cause the resin/rubber parts to deform/be damaged.
- (3) Prevent foreign material, such as cutting chips or coolant, from entering the product. Failure to do so may cause damage.
- (4) If foreign material such as cutting chips adheres to the product, replenish the lubricant after cleaning the product.
- (5) Cam Followers are designed for use under a radial load. Do not use the product under a thrust load.
- (6) Micro-oscillation can prevent the lubricant from coating the surface where balls meet the raceway, which can lead to fretting. To prevent this, use a grease with superior fretting resistance. THK also recommends periodically rotating the Cam Follower at least once to ensure that the raceway and balls are coated with lubricant.
- (7) Insufficient rigidity or accuracy of mounting members causes the bearing load to concentrate on one point and the bearing performance will drop significantly. Accordingly, give sufficient consideration to the rigidity/accuracy of the housing and base and strength of the fixing bolts.

[Lubrication]

- (1) The Cam Follower uses lithium soap-based grease No. 2 as standard grease. (Model CFN uses THK AFC Grease.)
Replenish the lubricant whenever necessary. Do not combine different lubricants. Mixing lubricants can cause adverse interaction between disparate additives or other ingredients. (See **■19-17**, Contamination Protection and Lubrication.)
- (2) Prior to using the product, apply lubricant between the Cam Follower and the rolling contact surface as well.
- (3) CF24, CFH24 or larger Cam Followers with hexagon sockets (symbol - A, excluding SUS models) are constructed with a plug fitted into the through hole that links the hexagon socket to the greasing hole (see dimensional drawing ϕd_1 , ϕd_2 **■19-20**) to prevent grease leakages from the hexagon socket.
During lubrication, take care to ensure that the plug is not forced out of the hexagon socket by excessive pressure.
- (4) When using the product in locations exposed to constant vibrations or in special environments such as clean rooms, vacuum and low/high temperature, use the grease appropriate for the specification/environment.
- (5) The consistency of grease changes according to the temperature. Take note that the slide resistance of the Cam Follower also changes as the consistency of grease changes.
- (6) After lubrication, the slide resistance of the Cam Follower may increase due to the agitation resistance of grease. Be sure to perform a break-in to let the grease spread fully, before operating the machine.

- (7) Even when the unit is equipped with seals, excess grease may spatter during initial use and immediately after lubrication. If necessary, wipe off any spattered grease.
- (8) The properties of grease deteriorate and its lubrication performance drops over time, so grease must be checked and added properly according to the use frequency of the machine.
- (9) The greasing interval varies depending on the use condition and service environment. Set the final lubrication interval/amount based on the actual machine.

[Storage]

When storing the Cam Follower, enclose it in a package designated by THK and store it in a room while avoiding high temperature, low temperature and high humidity.

After the product has been in storage for an extended period of time, lubricant inside may have deteriorated, so add new lubricant before use.

[Disposal]

Dispose of the product properly as industrial waste.



Cam Follower

THK General Catalog

Cam Follower

THK General Catalog

B Support Book

Features and Types	B 19-4
Features of the Cam Follower	B 19-4
• Structure and Features	B 19-4
• Cam Follower with Grease Nipple	B 19-5
• Cam Follower Containing Thrust Balls	B 19-5
Types of the Cam Follower	B 19-6
• Types and Features	B 19-6
• Options	B 19-9
Classification Table	B 19-10
Point of Selection	B 19-12
Nominal Life	B 19-12
Track Load Capacity	B 19-14
• Example of Calculating a Track Load Capacity ...	B 19-14
Mounting Procedure and Maintenance ..	B 19-15
Installation	B 19-15
Contamination Protection and Lubrication ..	B 19-17
Accessories	B 19-18
Cam Follower Accessories	B 19-18
Grease nipple	B 19-19
Model No.	B 19-20
• Model Number Coding	B 19-20
Precautions on Use	B 19-22

A Product Descriptions (Separate)

Features and Types	A 19-4
Features of the Cam Follower	A 19-4
• Structure and Features	A 19-4
• Cam Follower with Grease Nipple	A 19-5
• Cam Follower Containing Thrust Balls	A 19-5
Types of the Cam Follower	A 19-6
• Types and Features	A 19-6
• Options	A 19-9
Classification Table	A 19-10
Point of Selection	A 19-12
Nominal Life	A 19-12
Track Load Capacity	A 19-13
Accuracy Standards	A 19-14
Radial Clearance	A 19-14
Dimensional Drawing, Dimensional Table	
Model CF-AB Cam Follower with Grease Nipple ..	A 19-16
Model CF (Popular Type)	A 19-18
Cam Follower with Hexagon Socket Model CF-A ..	A 19-20
Eccentric Cam Follower with Grease Nipple Model CFH-AB ..	A 19-22
Eccentric Cam Follower with Hexagon Socket Model CFH-A ..	A 19-24
Cam Follower Containing Thrust Balls Model CFN-R-A ..	A 19-26
Cam Follower with Tapped Greasing Hole Model CFT ..	A 19-28
Outer-ring Compact-type Cam Follower Model CFS-A ..	A 19-30
Easy-mount Cam Follower Model CF-SFU ..	A 19-32
Double-row Cylindrical-roller Cam Follower Model NUCF-AB ..	A 19-34
Point of Design	A 19-36
Fit	A 19-36
Installation	A 19-36
Accessories	A 19-38
Cam Follower Accessories	A 19-38
Grease nipple	A 19-39
Model No.	A 19-40
• Model Number Coding	A 19-40
Precautions on Use	A 19-42

Features of the Cam Follower

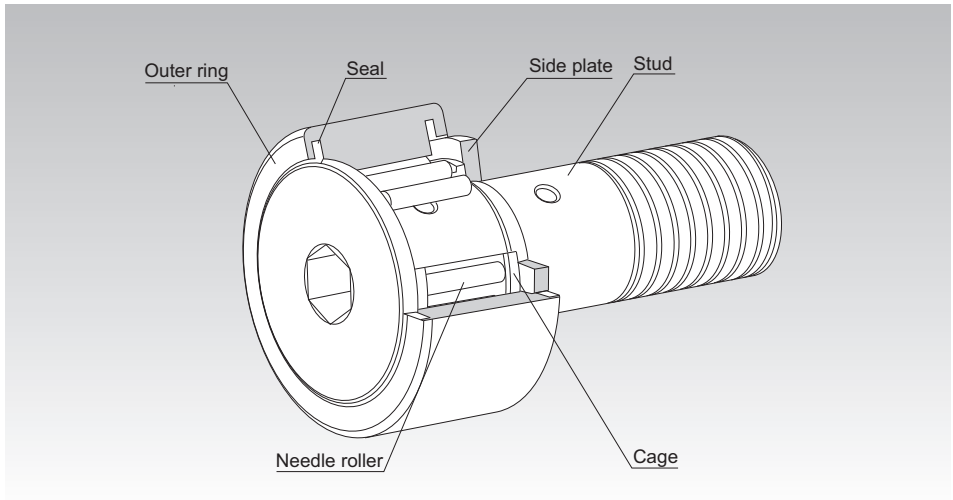

Fig.1 Structure of Cam Follower Model CF...UU-A

Structure and Features

The Cam Follower is a compact and highly rigid bearing with a shaft. It contains needle rollers and is used as a guide roller for cam mechanisms or straight motion.

Since its outer ring rotates while keeping direct contact with the mating surface, this product is thick-walled and designed to bear an impact load.

Inside the outer ring, needle rollers and a precision cage are incorporated. This prevents the product from skewing and achieves a superb rotation performance. And, as a result, the product is capable of easily withstanding high-speed rotation.

There are two types of the outer ring in shape: spherical and cylindrical. The spherical outer ring easily absorbs a distortion of the shaft center when the cam follower is installed and helps lighten a biased load.

The Cam Follower is used in a wide range of applications such as cam mechanisms of automatic machines, dedicated machines as well as carrier systems, conveyors, bookbinding machines, tool changers of machining centers, pallet changers, automatic coating machines, and sliding forks of automatic warehouses.

Cam Follower with Grease Nipple

With previous models it was necessary to fabricate a jig in order to install a plug or grease nipple. The Model CF-AB Cam Follower with grease nipples comes equipped with grease nipples on both sides, so it can be used immediately, without modification.

An Allen wrench can be used to anchor the stud from either the head or the threaded end, and it can be lubricated from either end as well. This ensures that there will be adequate space to install the unit and perform maintenance, improving work efficiency.

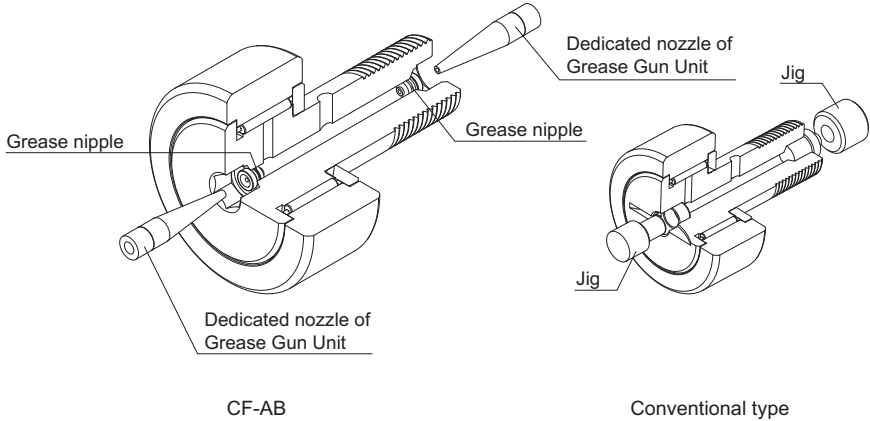

Cam Follower Containing Thrust Balls

Even a slight mounting error in a high speed cam mechanism operating in a harsh environment could cause abnormal wear to the thrust unit of the cam follower. In such a case, using Cam Follower Containing Thrust Balls model CFN will bring about a significant effect in increasing the durability.

Models CFN5 to 12 are standard-stock items. If desiring a size other than the standard items, contact THK.

Model CFN is capable of receiving a thrust load caused by a slight mounting error. However, it is necessary to minimize a component of thrust force, or prevent it from occurring, when designing the cam mechanism and installing the Cam Follower.

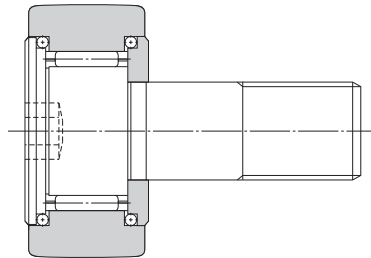

Fig.2

Types of the Cam Follower

Types and Features

Cam Follower with Grease Nipple Model CF-AB

Specification Table⇒ [A19-16](#)

A hexagonal socket is provided on both stud ends, and a grease nipple for greasing is fitted to the inside. Therefore, lubrication and mounting from both directions is possible.

Stud diameter: 12–30 mm

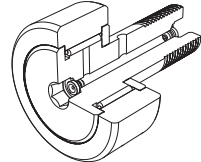

Model CF-AB

Popular Type Cam Follower Model CF

Specification Table⇒ [A19-18](#)

It is a popular type of Cam Follower provided with a driver groove on the head of the stud.

Stud diameter: 5–10 mm

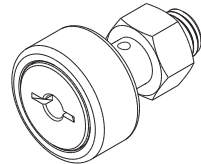

Model CF

Cam Follower with a Hexagon Socket Model CF-A

Specification Table⇒ [A19-20](#)

Since the stud head has a hexagon socket, this model can easily be installed using a hexagon wrench.

Stud diameter: 3–10 mm

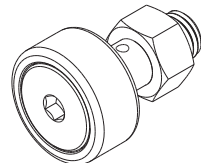

Model CF-A

Eccentric Cam Follower Models CFH-AB, CFH-A

Specification Table⇒ **A** 19-22

Because there is an eccentricity of 0.25 to 1.0 mm between the mounting shaft of the stud and the stud head, slight positioning adjustments can easily be made simply by rotating the stud. This eliminates the need to align the cam follower with the cam groove or perform precision machining on the mounting hole, greatly reducing the time and labor required for machining and assembly.

Model CFH-AB: Equipped with grease nipple and hexagonal sockets; compatible with stud diameters of 12 to 30 mm.

Model CFH-A: Equipped with hexagonal sockets; compatible with stud diameters of 5 to 10 mm.

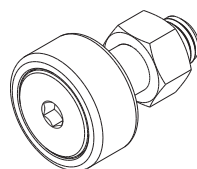

Model CFH-A

Cam Follower Containing Thrust Balls Model CFN-R-A

Specification Table⇒ **A** 19-26

On the inside, this Cam Follower model is equipped with thrust-load ball bearings. This effectively prevents friction and wear on the slip surface when a thrust load occurs due to faulty installation or the like.

Stud diameter: 5–12 mm

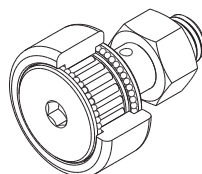

Model CFN-R-A

Cam Follower with a Tapped Hole for Greasing Model CFT

Specification Table⇒ **A** 19-28

Basically the same as the popular type Cam Follower, this model is provided with tapped holes for piping on the stud head and the thread.

It is optimal for locations where an integrated piping for greasing is required.

Stud diameter: 6–30 mm

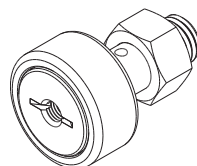

Model CFT

Outer-ring Compact-type Cam Follower Model CFS-A

Specification Table⇒ **A19-30**

This Cam Follower contains extremely fine needle rollers.

The outer ring external diameter is extremely small relative to the stud diameter, allowing a compact design.

Stud diameter: 2.5–6 mm

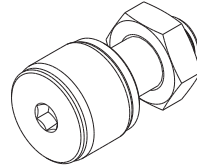

Model CFS-A

Easy-mount Cam Follower Model CF-SFU

Specification Table⇒ **A19-32**

For easy mounting, the stud is equipped with a slot enabling it to be secured with a screw. This greatly reduces the time and labor required for installation and is ideal for applications where there is no space to secure the stud with a nut.

Stud diameter: 6–20 mm

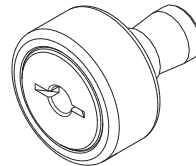

Model CF-SFU

Model NUCF-AB Double-row Cylindrical-roller Cam Follower

Specification Table⇒ **A19-34**

This model, which employs a double row of cylindrical rollers, can accommodate high radial loads.

A hexagonal socket is provided on both stud ends, and a grease nipple for greasing is fitted to the inside. Therefore, lubrication and mounting from both directions is possible.

Stud diameter: 16–30 mm

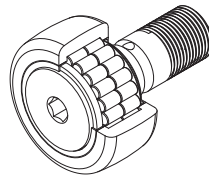

Model NUCF-AB

Options

Note: Different features and options are available, depending on the model. For details, please refer to the dimension table for the product in question.

● Roller guide

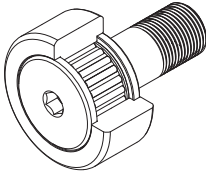

With cage (No Symbol)

The caged format, which offers optimal lubrication conditions, is best for high-speed rotation.

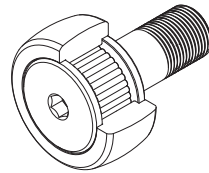

Full rollers (V)

The full-complement roller format is best for low-speed rotation and heavy loads.

Note: Please make sure to follow the lubrication schedule.

● Type of material

Carbon steel and stainless steel are available.

Stainless steel, which is more resistant to corrosion, is the best choice for use in clean rooms and other oil-free environments.

● With/without a seal

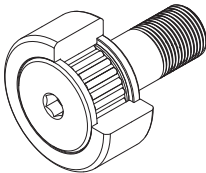

Without seal (No symbol)

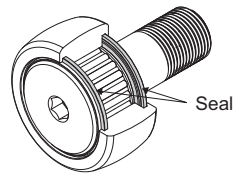

With seal (UU)

Equipped with a highly wear-resistant synthetic rubber seal to keep foreign matter out of the unit's interior.

● Outer ring outer surface configuration

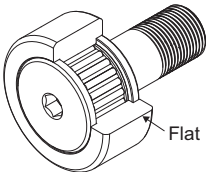

Cylindrical outer ring (No Symbol)

This model offers an expansive area of contact between rolling surfaces and is therefore ideal for heavy loads and low-rigidity rolling surfaces.

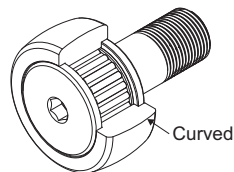

Spherical outer ring (R)

This helps alleviate the effects of an eccentric load in the event of adverse conditions around the outer ring and rolling surface.

Classification Table

	Model No.	Main dimensions				Options				
		Stud diameter	Outer diameter	Outer ring width	Overall length	Roller guide		Material		
		[mm]	[mm]	[mm]	[mm]	With cage	Full rollers	Carbon steel	Stainless steel	
Popular type	CF-AB	Φ12-30	Φ30-90	14-35	40-100	○	○	○	○	
	CF	Φ5-10	Φ13-26	9-12	23-36	○	○	○	○	
	CF-A	Φ3-10	Φ10-26	7-12	17-36	○	○	○	○	
Eccentric type	CFH-AB	Φ12-30	Φ30-90	14-35	40-100	○	○	○	○	
	CFH-A	Φ5-10	Φ13-26	9-12	23-36	○	○	○	○	
With thrust balls	CFN-R-A	Φ5-12	Φ13-30	9-14	23-40	○	—	○	—	
With tapped grease hole	CFT	Φ6-30	Φ16-90	11-35	28-100	○	○	○	○	
Compact outer ring type	CFS-A	Φ2.5-6	Φ5-12	3-7	9.5-21.5	○	○	○	○	
Easy-mount type	CF-SFU	Φ6-20	Φ16-47	11-24	32-50.5	○	—	○	—	
Double-row cylindrical-roller type	NUCF	Φ16-30	Φ35-90	18-35	52-100	—	○	○	—	

Note1) It is recommended to use nipples for greasing. Nipples can be attached at your request.

Note2) Nipples and fittings can be attached at your request.

					Features (installation and greasing)	Description page
Seal		Outer ring shape				
With	Without	Cylinder	Spherical surface			
○	○	○	○		Installation: Use the hex sockets located at both ends of the stud. Greasing: Use the internal nipples at either end or the grease hole drilled into the stud shaft.	A19-16
○	○	○	○		Installation: Use the driver groove in the stud head. Greasing: Use the grease hole* drilled into the stud head.	A19-18
○	○	○	○		Installation: Use the hex socket in the stud head. Greasing: Cannot re-grease.	A19-20
○	○	○	○		<ul style="list-style-type: none"> The position of the outer diameter of the outer ring can be fine-tuned with the eccentricity mechanism → Useful when installing and aligning multiple cam followers. Installation: Use the hex sockets located at both ends of the stud. Greasing: Use the internal nipples at either end.	A19-22
○	○	○	○		<ul style="list-style-type: none"> The height of the outer diameter of the outer ring can be fine-tuned with the eccentricity mechanism → Useful when installing and aligning multiple cam followers. Installation: Use the hex socket in the stud head. Greasing: Cannot re-grease.	A19-24
—	○	—	○		<ul style="list-style-type: none"> The thrust balls absorb axial loads to prevent friction and wear of the slip surface → Optimal for environments where installation errors, etc. may occur. Installation: Use the hex socket in the stud head. Greasing: Stud diameter 5 to 10 mm: Cannot re-grease. Stud diameter 12 mm: Use the grease hole* in the stud end or the grease hole drilled into the stud shaft.	A19-26
○	○	○	○		<ul style="list-style-type: none"> Tapped grease holes at both ends of the stud → Ideal for connecting to a central lubrication system, such as when using a large number of cam followers. Installation: Use the driver groove in the stud head. Greasing: Stud diameter 6 to 10 mm: Use a nipple or fitting on the stud head. Stud diameter 12 mm or larger: Use nipples or fittings on the stud ends or the grease hole drilled into the stud shaft.	A19-28
—	○	○	—		<ul style="list-style-type: none"> The outer diameter of the outer ring follows closely to that of the stud diameter → Allows for compact design Installation: Use the hex socket in the stud head. Greasing: Cannot re-grease.	A19-30
○	—	○	○		<ul style="list-style-type: none"> Designed to be fixed in place with set screws → Reduced assembly time makes it ideal when installing large numbers of cam followers. Installation: Lock into place with a set screw. Greasing: Use the grease hole* drilled into the stud head.	A19-32
—	○	○	○		<ul style="list-style-type: none"> Employs double rows of cylindrical rollers for high load capacity → Ideal for supporting heavy loads Installation: Use the hex sockets located at both ends of the stud. Greasing: Use the internal nipples at either end or the grease hole drilled into the stud shaft.	A19-34

Nominal Life

[Static Safety Factor]

The basic static load rating C_0 refers to the static load with constant direction and magnitude, under which the calculated contact stress in the center of the contact area between the roller and the raceway under the maximum load is 4000 MPa. (If the contact stress exceeds this level, it will affect the rotation.) This value is indicated as “ C_0 ” in the dimensional tables. When a load is statically or dynamically applied, it is necessary to consider the static safety factor as shown below.

$$\frac{C_0}{P_0} = f_s$$

f_s : Static safety factor in relation to C_0
(see Table1)

C_0 : Basic static load rating (kN)

P_0 : Radial load (kN)

The permissible load (F_0) indicates the permissible value of the applied load determined by the strength of the stud section of the Cam Follower. Therefore, it is necessary to consider the static safety factor f_M against F_0 as well as f_s .

$$\frac{F_0}{P_0} = f_M$$

f_M : Static safety factor in relation to F_0
(see Table1)

F_0 : Permissible load (kN)

P_0 : Radial load (kN)

* The minimum value for the static safety factor is based on the presumption of appropriate lubrication and optimal conditions for mounting and assembly. It is not possible to calculate the effect on internal loads that may be caused by improper mounting, deformation of mounting components, or the like. Please take all necessary action to ensure safety.

Table1 Static Safety Factor (f_s, f_M)

Load conditions	Lower limit of f_s and f_M
Normal load	1 to 2
Impact load	2 to 3

[Nominal Life]

The service life of the Cam Follower is obtained from the following equation.

$$L = \left(\frac{f_r \cdot C}{f_w \cdot P_c} \right)^{\frac{10}{3}} \times 10^6$$

L : Nominal life
(The total number of revolutions that 90% of a group of identical Cam Follower units independently operating under the same conditions can achieve without showing flaking from rolling fatigue)

C : Basic dynamic load rating (kN)

P_c : Radial load (kN)

f_r : Temperature factor
(see Fig.1 on **B19-13**)

f_w : Load factor
(see Table2 on **B19-13**)

* The basic dynamic load rating (C) of the Cam Follower shows the load with interlocked direction and magnitude, under which the nominal life (L) is 1 million revolutions when a group of identical Cam Follower units independently operate. The basic dynamic load rating (C) is indicated in the corresponding specification table.

[Calculating the Service Life Time]

When the nominal life (L) has been obtained, the service life time (L_h) is obtained from the following equation.

● For Linear Motion

$$L_h = \frac{D \cdot \pi \cdot L}{2 \times \ell_s \cdot n_1 \times 60} \quad (h)$$

L_h : Service life time
 L : Nominal life
 D : Bearing outer diameter (mm)
 ℓ_s : Stroke length (mm)
 n₁ : Number of reciprocations per minute (min⁻¹)

● For Rotary Motion

$$L_h = \frac{D \cdot L}{D_1 \cdot n \times 60}$$

D₁ : Outer ring contact average diameter of the cam (mm)
 n : Revolutions per minute of the cam (min⁻¹)

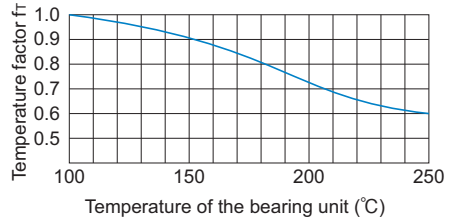

Fig.1 Temperature Factor (f_t)

Note) The normal service temperature is 80°C or below. If the product is to be used at a higher temperature, contact THK.

Table2 Load Factor (f_w)

Condition	f _w
Smooth motion without impact	1 to 1.2
Normal motion	1.2 to 1.5
Motion with severe impact	1.5 to 3

Track Load Capacity

The track load capacity means the permissible load at which the outer ring of a bearing and the mating surface are capable of withstanding repeated use over a long period.

The track load capacity provided in the specification table indicates the value when using a steel material with tensile strength of 1.24 kN/mm² as the mating material. Therefore, it is possible to increase the track load capacity by increasing the hardness of the material. Fig.2 shows the hardness of the mating material and the track capacity factor in relation to tensile strength. To obtain the track load capacity of each mating material, multiply the track load capacity shown in the corresponding specification table by the respective track load factor.

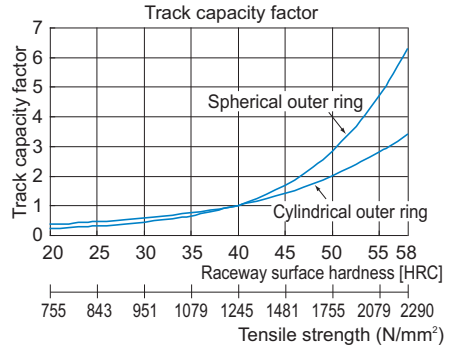

Fig.2 Track Capacity Factor

Note) For the mating material, we recommend using those materials with the raceway hardness of 20 HRC or higher and the tensile strength of 755 N/mm² or higher.

Example of Calculating a Track Load Capacity

Obtain the track load capacity when heat-treating the mating material, which a bearing whose outer ring has a track load capacity of 5.29 kN contacts, to hardness of 50 HRC.

The track capacity factor when the hardness is 50 HRC is 2.84, as indicated in Fig.2. Therefore, the desired track load capacity is calculated as follows.

The track load capacity = $5.29 \text{ kN} \times 2.84 = 15.0 \text{ kN}$

Installation

[Installing the Cam Follower]

If the Cam Follower is to be used under a heavy load, it is necessary to install the product so that the greasing hole on the stud is out of the loaded area. To help identify the position of the greasing hole, the THK logo is marked on the side face of the stud collar. (See Fig.1.)

The vertical hole in the middle of the stud is used as a whirl stop or a greasing hole.

Make sure that the outer ring is evenly in contact with the mating surface. When installing the Cam Follower, also make sure its axis is perpendicular to the traveling direction.

[Installing the Eccentric Cam Follower]

The eccentricity is adjusted in the following steps.

- (1) Insert the stud into the mounting hole, and lightly tighten the nut until the nut starts turning. In doing so, position the THK logo in relation to the load direction as shown in Fig.2.
- (2) Use the hexagon socket on the stud head to turn the stud and adjust the clearance between the stud and the mating contact surface.
- (3) After adjusting the clearance, tighten the nut while keeping the stud from turning. Be sure the maximum tightening torque in (see **B19-16** on Table1) is not exceeded.

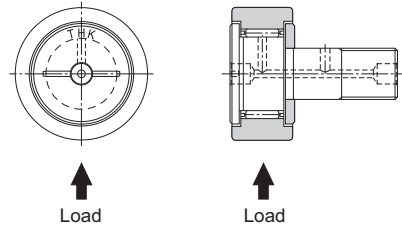

Fig.1 Positions of the THK Logo and the Greasing Holes

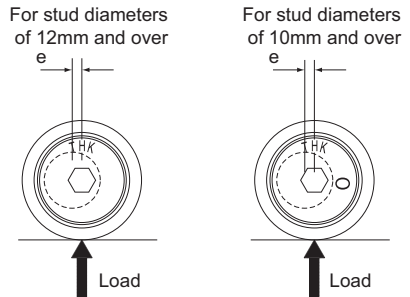

Fig.2 Position relative to eccentric direction

● **Using spring washers**

If a spring washer is used to secure a cam follower, take care to check that the spring washer has no burrs or sharp edges. If there are burrs or sharp edges, contact between burrs or edges and the nut or flash washer used for mounting will cause abrasion and the abraded fragments will adhere to the stud screw. This will result in damage or incomplete tightening when the nut is tightened and may damage the screw section.

● **About the installation procedure**

When mounting the Cam Follower, secure the flat-blade screwdriver groove and the hex wrench and turn the nut using a spanner. If turning the flat-blade screwdriver groove and the hex wrench side, the flat-blade screwdriver groove or the hexagon hole of the Cam Follower may be fractured.

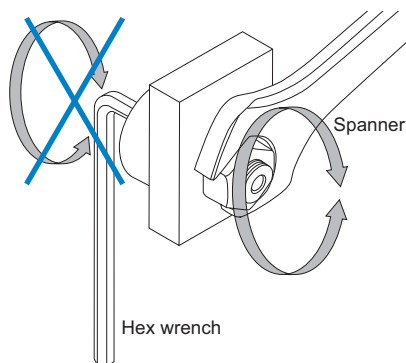

● **Tightening Torque for the Stud**

Since the stud of the Cam Follower receives bending stress and tensile stress caused by a bearing load, it is necessary to keep the tightening torque of the screw from exceeding the values indicated in Table1.

If the mounting screw may be loosened due to vibrations or impact, use a spring washer, thin nuts of JIS B 1181 Class 3 as double-nuts or a special nut capable of preventing itself from loosening.

Table1 Maximum Tightening Torque of the Screw

Model No CF, CFN, CFH, CFT, CFS and NUCF	Maximum tightening torque N-m
2.5	0.18
3	0.392
4	0.98
5	1.96
6	2.94
8	7.84
10 10-1	16.7
12 12-1	29.4
16	70.6
18	98
20 20-1	137
24 24-1	245*
30 30-1 30-2	480*

Note)* is the value in case of the standard material (carbon steel). If a stainless steel type is to be used, the maximum value is 70% of this value. 1 N-m equals to 0.102 kgf-m.

Contamination Protection and Lubrication

Cam Followers can be equipped with highly wear-resistant synthetic rubber seals to keep foreign matter out of the unit's interior. A "UU" in the product code signifies a model equipped with seals.

Since the Cam Follower contains high-quality lithium soap based grease No. 2, you can start using the product without replenishing grease. Model CFN contains THK AFC Grease.

Prior to using the product, apply lubricant between the Cam Follower and the rolling contact surface as well.

To replenish the Cam Follower with grease, fill grease into the greasing hole on the stud. However, note that some of the models with stud diameters of 10 mm or less do not have a greasing hole and are provided with initial lubrication only, and therefore do not allow replenishment of grease.

Please note that when replenishing lubricant from the grease nipple, the dedicated attachments (included with grease gun unit MG70) vary depending on the cam follower model number. (See Table2)

Table2 Table for Supported Model Numbers

Model number	Corresponding nipple model number	Attachment Type
CF(H)-AB NUCF-AB	—	Type P
CF	NP3,2×3.5, PB1021B, NP6×5, NP8×9	Type N
CFH		
CFN		
CF-SFU		
CFT	M6F, PT1/8	Type H

* CF(H)-AB and NUCF-AB models are pre-fitted with grease nipples.
 Note) For the dimensions and shapes of the attachments, see **A24-24**.

The appropriate fill quantity is a half to one third of the space inside the bearing. The lubrication interval varies depending on the operating conditions. As a guide, however, replenish grease of the same group every six months to two years for types with a cage, or every one to 6 months for full-roller types.

Even with types equipped with seals ("...UU"), surplus grease may seep during the initial operation period or immediately after resumption of grease replenishment. If desiring to avoid contamination of the surrounding area of the machine by grease, first perform seasoning or the like in advance, and then wipe the seeping surplus grease.

When driving the dedicated grease nipple onto the Cam Follower, use a jig like the one shown in Fig.3 to provide pressure to the flange of the nipple.

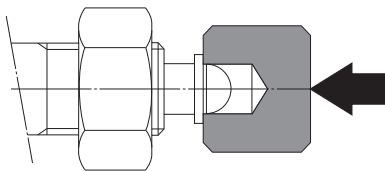

Fig.3

Cam Follower Accessories

The standard cam follower accessories are shown in Table1.

The stopper plug is used to prevent grease from leaking out. The filler plug is used to seal an unused oil hole. Both must be used with care: once inserted, they cannot be removed. Use either of these two items, in accordance with the intended application, when not using a grease nipple.

Table1 Accessories

Model number	Stud diameter(mm)	Stopper plug	Filler plug	Nut JIS Class 2	Grease
CF-AB		—	—	Included	Filled
CF	5	—	—	Included	Filled
	6 or larger	Included	—	Included	Filled
CF-A		—	—	Included	Filled
CFH-AB		—	—	Included	Filled
CFH-A		—	—	Included	Filled
CFN-A	10 or smaller	—	—	Included	Filled
	12	Included	Included	Included	Filled
CFT		—	— ^{Note1)}	Included	Filled
CFS		—	—	Included	Filled
CF-SFU	10 or smaller	Mounting bolt	—	—	Filled
	12 or larger	Mounting bolt	Included	—	Filled
NUCF-AB		—	—	Included	Filled

Note1) If a plug for model CFT is required, please contact THK.

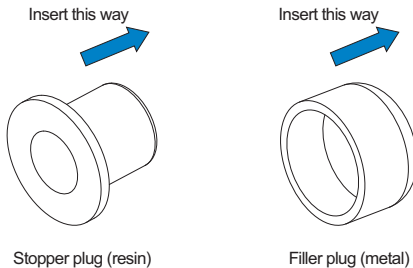

Grease nipple

If a grease nipple is required, please add the symbol "N" to the end of the part number. The grease nipple shown in Table2 will be attached. When ordering the model CFT, indicate which type of grease nipple is to be attached.

The attachment for the grease gun unit MG70 varies according to the cam follower model, as shown in Table2.

For the size and shape of each grease nipple, see **A24-24** to **A24-26**.

Example: CF 10 UUR -N

 Dedicated grease nipple

Table2 Grease nipple correspondence table

Model number Stud diameter(mm)		Nipple	Attachment Type
CF-AB		Embedded ^{Note1)}	Type P
CF	5	NP3.2×3.5	Type N
	6 or more	PB1021B	Type N
CF-A		— ^{Note2)}	—
CFH-AB		Embedded ^{Note1)}	Type P
CFH-A		— ^{Note2)}	—
CFN-A	10 or less	— ^{Note2)}	—
	12	NP6×5	Type N
CFT	12 or less	A-M6F,B-M6F,C-M6F	Type H
	16 or more	A-PT1/8,B-PT1/8,C-PT1/8	Type H
CFS		— ^{Note2)}	—
CF-SFU	6 to 10	PB1021B	Type N
	12 to 18	NP6×5	Type N
	20	NP8×9	Type N
NUCF-AB		Embedded ^{Note1)}	Type P

Note1) CF(H)-AB and NUCF-AB models are pre-fitted with grease nipples. These models come with grease nipples attached even if "N" is not added to the model number when ordering.

Note2) Cannot re-grease

Model Number Coding

Model number configurations differ depending on the model features. Refer to the corresponding sample model number configuration.

[Cam Follower with Grease Nipple]

● Models CF-AB, CFH-AB and NUCF-AB

CF12 V M UU R -AB

Model No. AB : Stud with hexagonal socket at both ends
 No symbol: With cage No Symbol : Cylindrical outer ring
 V : Full-roller Type R : Spherical outer ring
 No symbol: Carbon steel No symbol: Without seal
 M : Stainless steel UU : With seal

NUCF16 R -AB

Model No. AB : Stud with hexagonal socket at both ends
 No Symbol: Cylindrical outer ring
 R : Spherical outer ring

[Cam Follower]

● Models CF, CFH, CFN, CFT and CFS

CF10 V M UU R -A N

Model No. No Symbol : No grease nipple
 N : Dedicated grease nipple included (See [B 19-19](#))
 No symbol: With cage No Symbol : Flat-head Slot
 V : Full-roller Type -A : Stud head with a hexagon socket
 No symbol: Carbon steel
 M : Stainless steel
 No Symbol : without seal No Symbol : Cylindrical outer ring
 UU : With seal R : Spherical outer ring

* Because support will vary depending on the model number, please refer to each dimensional table for details.

[Easy-mount Cam Follower]

- Models CF-SFU and CF-SFU-R

CF-SFU-6 R

No Symbol: Cylindrical outer ring
R : Spherical outer ring

* CF-SFU models are fitted with UU seals even where no UU symbol is used.

[Handling]

- (1) Do not disassemble the parts. This will result in loss of functionality.
- (2) Take care not to drop or strike the Cam Follower. Doing so may cause injury or damage. Giving an impact to it could also cause damage to its function even if the product looks intact.
- (3) When handling the product, wear protective gloves, safety shoes, etc., as necessary to ensure safety.

[Precautions on Use]

- (1) Use a torque wrench or a similar tool to tighten the nut when installing the Cam Follower, using the appropriate fastening torque set forth in **■19-16** on Table1.
- (2) Do not use the product at temperature of 80°C or higher. Exposure to higher temperatures may cause the resin/rubber parts to deform/be damaged.
- (3) Prevent foreign material, such as cutting chips or coolant, from entering the product. Failure to do so may cause damage.
- (4) If foreign material such as cutting chips adheres to the product, replenish the lubricant after cleaning the product.
- (5) Cam Followers are designed for use under a radial load. Do not use the product under a thrust load.
- (6) Micro-oscillation can prevent the lubricant from coating the surface where balls meet the raceway, which can lead to fretting. To prevent this, use a grease with superior fretting resistance. THK also recommends periodically rotating the Cam Follower at least once to ensure that the raceway and balls are coated with lubricant.
- (7) Insufficient rigidity or accuracy of mounting members causes the bearing load to concentrate on one point and the bearing performance will drop significantly. Accordingly, give sufficient consideration to the rigidity/accuracy of the housing and base and strength of the fixing bolts.

[Lubrication]

- (1) The Cam Follower uses lithium soap-based grease No. 2 as standard grease. (Model CFN uses THK AFC Grease.)
Replenish the lubricant whenever necessary. Do not combine different lubricants. Mixing lubricants can cause adverse interaction between disparate additives or other ingredients. (See **■19-17**, Contamination Protection and Lubrication.)
- (2) Prior to using the product, apply lubricant between the Cam Follower and the rolling contact surface as well.
- (3) CF24, CFH24 or larger Cam Followers with hexagon sockets (symbol - A, excluding SUS models) are constructed with a plug fitted into the through hole that links the hexagon socket to the greasing hole (see dimensional drawing ϕd_1 , ϕd_2 **■19-20**) to prevent grease leakages from the hexagon socket.
During lubrication, take care to ensure that the plug is not forced out of the hexagon socket by excessive pressure.
- (4) When using the product in locations exposed to constant vibrations or in special environments such as clean rooms, vacuum and low/high temperature, use the grease appropriate for the specification/environment.
- (5) The consistency of grease changes according to the temperature. Take note that the slide resistance of the Cam Follower also changes as the consistency of grease changes.
- (6) After lubrication, the slide resistance of the Cam Follower may increase due to the agitation resistance of grease. Be sure to perform a break-in to let the grease spread fully, before operating the machine.

- (7) Even when the unit is equipped with seals, excess grease may spatter during initial use and immediately after lubrication. If necessary, wipe off any spattered grease.
- (8) The properties of grease deteriorate and its lubrication performance drops over time, so grease must be checked and added properly according to the use frequency of the machine.
- (9) The greasing interval varies depending on the use condition and service environment. Set the final lubrication interval/amount based on the actual machine.

[Storage]

When storing the Cam Follower, enclose it in a package designated by THK and store it in a room while avoiding high temperature, low temperature and high humidity.

After the product has been in storage for an extended period of time, lubricant inside may have deteriorated, so add new lubricant before use.

[Disposal]

Dispose of the product properly as industrial waste.

